

Recent Development in Device Technology for Integrated THz-Circuits

H. L. Hartnagel, C.-I. Lin, M. Rodriguez, V. Ichizli, M. Saglam, P. Szeliga

Institut für Hochfrequenztechnik, TU Darmstadt
Merckstrasse 25, D-64283 Darmstadt, Germany
Tel: ++49 (0) 6151 16 2162
FAX: ++49 (0) 6151 16 4367
e-mail: thzuser@hf.tu-darmstadt.de

ABSTRACT

Recently there is significantly increasing interest in the development of THz devices and circuits. Different from the MMIC device and circuit technologies, THz devices approach to the electrical limit of semiconductors and passive THz circuit elements have much less dimension tolerance. Therefore, device and circuit technologies concerning to such limitations have to be reconsidered and modified. In this paper a review of the important device technologies used in the THz frequency regime is presented.

INTRODUCTION

Increasing interest in environmental science, radio astronomy and plasma diagnostics to detect signals in the submillimeter range, as well as civil applications like distance sensing at 66 GHz in automobile industries enhance the development of the techniques related to devices and circuits working in the submillimeter range. Very fast non-linear devices with cut-off frequency over one THz have to be used in the submillimeter wave region for either mixing or frequency multiplying. GaAs Schottky diodes belong to the fastest electronic semiconductor devices available due to the high electron mobility, absence of minority carriers and simple structure working at the room temperature. Using the planar device technology with a micro air-bridge, the disadvantage of conventional whisker contacted diodes without integration possibility can be overcome. In addition, the planar device technology allows also other passive circuit elements such as antennas or filters to be integrated with the diode. The chip size of an integrated THz circuit is usually around 1 mm x 1mm, where the diode is with a diameter of a few micrometer. Therefore, a precise control in the diode fabrication over large area is necessary. The smaller dimension of the passive circuit elements with the higher frequencies, size, shape and adhesion control of those elements have to get attention to achieve a proper performance. To realise expected characteristics of those passive elements, 3-D electromagnetic simulation programs for millimetre and submillimeter wave range have to be utilised. With suitable choice of models, the simulation programs can predict the behaviour of circuits precisely. Such success enhance the will to integrate non-linear devices directly with passive circuit elements on the semiconductor substrate. The first part of this paper concentrates on the diode technology development, while the second part is devoted to the consideration of the integration.

SCHOTTKY DIODE TECHNOLOGY

In order to get homogeneous integration over large areas, intensive investigation on the diode technologies has to be made. Three in the whole fabrication steps of planar diodes are considered to be critical and could influence the performance of the diode:

- *Passivation:*

The passivation layer on the device surface has the function to passivate the surface of the diode. Unlike silicon, a isolated thermal-oxidation layer can not be produced on GaAs surface as passivation. Therefore, other techniques are applied to realise a passivation layer on GaAs surface. One of the common techniques is the Plasma Enhanced Chemical Vapour Deposition (PECVD), which produces stable, well adhered and reproducible SiO₂ and Si₃N₄ passivation layers without degradation of the semiconductor surface. For the Pt/n-GaAs Schottky diodes applications in THz region, SiO₂ passivation is the standard technique. Nevertheless, with SiO₂ passivation, the achieved breakdown voltages are always much lower than theoretically predicted values. For frequency multiplier applications, however, such poor breakdown voltages can lead to a reduction of the output power and the conversion efficiency. With the optimised passivation technique, the breakdown voltage of Schottky varactor diodes can be increased significantly. Fig. 1 shows a comparison of the breakdown voltage with different compositions of SiO₂ and Si₃N₄ in the passivation layer. Using this technique, a whisker contacted Schottky varactor diode with a doping level of 8E16 cm⁻³, a series resistance of 12 Ω, a zero-bias junction capacitance of 13 fF received a breakdown voltage of 16 V. This diode was applied into a fixed tuned doubler from IRAM for the frequency range of 133 - 180 GHz and enabled a 22% bandwidth with a peak output power of 2 mW at 162 GHz.

- *Reactive Ion Etching:*

The most critical step in the fabrication of Schottky diode for THz applications is the opening of the anode window in the passivation layer. Wet-chemical etching is not suitable here because of the small anode window opening and poor repeatability. Reactive ion etching (RIE) provides an accurate procedure to perform this task due to its excellent degree of anisotropy in the removal of the passivation layer. However, it causes also damage on the

semiconductor surface which introduces excess noise to the device. Within investigation of improvement of the noise performance of Pt/n-GaAs Schottky diodes, it is verified that thermal annealing in H₂ environment can reduce the excess noise caused by RIE significantly. Figure 2 shows a comparison of the noise temperature measured at 1.5 GHz of two diode groups with/without thermal annealing after different RIE-process times from 8 minutes to 28 minutes, where 12 minutes is expected to open through the 300 nm thick passivation layer. Using the optimised RIE technique, substrateless Schottky mixer diodes for corner cube mixer at 2.5 THz were fabricated. Recently, a DSB mixer noise temperature of 16500 K was achieved at the University of Erlangen, Germany.

- *Micro air-bridge Optimisation for Small Scaled Microwave Devices:*

Adhesion of a deposited metal to semiconductor, insulator or another metal is very important for mechanical stability of semiconductor devices and integrated circuits. Especially sensible to poor adhesion are air-bridges, thin interconnects, and their junctions to the contacting pads. We have achieved high adhesion of electroplated gold to a Pt/Au-Schottky contact with a MBE-grown wafer with n-GaAs top layer by preceding the Au-layer with a sputtered Ni/Ag/Ni seed layer. After anode deposition and mesa formation for a Schottky-diode, the needed air-bridge and pad shapes are determined by a photoresist mask fabricated with means of photolithography, a Ni(20nm)/Ag(80nm)/Ni(50nm) seed layer is deposited by sputtering. This enables a very dense, well adhesive layer being able to be quite well removed selectively to GaAs with different etchants. Optimisation of selective removal of this seed layer with presence of plated Gold was performed, in order to avoid large undercutting which can lead to disconnection of the interconnects, contacting pads, etc. from the substrate. Figure 3 shows the best repeatable results achieved by the etching optimisation with minimum undercutting which supports the high adhesion of the seed layer and provides a high robustness of the micro air-bridge structure. Fig. 4 shows some different planar diodes are fabricated using the techniques for the considered critical steps.

TECHNOLOGIES FOR MONOLITHIC INTEGRATION

In addition to the device technologies, further technologies such as coplanar waveguides and microstrip waveguides for realising planar circuit elements are necessary for the monolithic integration. However, the devices as well as the circuit elements are getting electromagnetically large as the frequencies increase. Therefore, different as the simulation and design technologies in the millimeter wave region with a relatively large tolerance in the design, sub-millimeter wave circuits have to be considered more carefully. Any discontinuity along the circuit lines can not be neglected. Therefore, 3-D electromagnetic simulators such as High Frequency Structure Simulator or Microwave Studio have to be applied to calculate their characteristics and transfer them into S-parameter for system performance optimisation. Fig. 5a shows an example of a layout of a 4-receiver array for imaging of electron temperature in fusion plasmas. Fig. 5b shows the simulated conversion loss versus output frequency for different input power levels.

From the fabrication point of view, several points are critical for the monolithic integration:

- *Shape and dimension of the circuit elements:*

Because the dimension of the circuit elements in the THz regime are comparable to the allowed error of the fabrication process, therefore, the uncertainty of the variation of the dimension of every circuit elements such as the line width and shape, the antenna dimension as well as the space between lines and ground, have to be also considered in the design phase, in order to make the simulation results near to the reality.

- *Process and yield control:*

Because the used chip area is much larger than single devices, it is important to rise the homogeneity, repeatability and yield of the critical steps to make the realised chip working properly.

Integration of one or more Schottky diodes with some circuit elements like antenna and filter structures provide many possibilities to THz applications such as power combining system, THz imaging and integrated receiver. Several examples of monolithic integration are given as following: Fig. 6 presents an anti-parallel diode pair integrated with a filter structure for the mixing application in a waveguide. Fig. 7 shows a quasi-optic frequency multiplier using a Schottky diode array with 7 diodes integrated with crossed dipole antennas for input and output frequency [4]. Fig. 8 is a prototype of a monolithically integrated quasi-optic receiver using the microstrip technique [5].

CONCLUSION

In this paper we present the recent research activities in the THz Electronics at TU Darmstadt. Different focus points on the optimisation of device technologies, the simulation techniques and the process control are continuously under investigation. For monolithic SMMW circuits, using the experience in the MMIC technique allows us to make complicate circuit designs. Due to the fact that the dimension of devices and circuit elements become electromagnetically much larger, detailed considerations of the structure geometry are necessary. In addition, because of the dramatically reduced number of devices on one chip, a careful review of critical process steps and establishment of process control have to be done for a high yield of devices.

ACKNOWLEDGMENT

This work includes several research projects 'MM and Sub-MM Wave Open Structure Integrated Receiver Front-End Technology Development', 'Critical Technologies for MMW Radiometers' and 'Establish a Controlled Fabrication

Process for MM and Sub-MM Wave Schottky Diode Components' funded by ESA/ESTEC, Noordwijk, as well as the project 'MMIC Receiver Array for Plasma ECE diagnostics' funded by Max-Planck-Institut, Garching, and the TMR program from EU. The authors also would like to express their gratitude to the co-operation partners from Institute for Semiconductor Electronics at TU Darmstadt for the RIE and PECVD facilities, from Technical University Munich for the MBE wafers, from Lehrstuhl für Hochfrequenztechnik at TU Erlangen for the 2.5 THz measurements and from IRAM for the 160 GHz doubler measurements.

REFERENCES

- [1] H. L. Hartnagel and C.-I. Lin, "Passivation of Compound-Semiconductor Surfaces For Low-Noise Terahertz Devices", *International Seminar on Semiconductor Surface Passivation*, Ustron, Poland, September 19-22, 1999
- [2] J. M. M. Pantoja, C.-I. Lin, M. Brandt, M. Rodríguez-Gironés, H. L. Hartnagel, J. L. Sebastian. "Influence of Reactive Ion Etching Technologies on the Microwave Noise Generated by Metal-Semiconductor Interfaces of Pt/n-GaAs Schottky Diodes", *accepted to be published IEEE Electron Device Letters*.
- [3] M. Rodríguez-Gironés, J. P. Pascual, S. Bäuml, C.-I. Lin, H. L. Hartnagel, "A 150 GHz Fully-Integrated MMIC Schottky-Mixer Array", *accepted to be published in the 8th international Conference on Terahertz Electronics*, Sept. 28th-29th, Darmstadt, Germany.
- [4] D. Steup, A. Simon, M. Shaalan, A. Grüb, C.-I. Lin, "A Quasioptical Doubler-Array", *International Journal Infrared & Millimeter Waves*, vol. 17, No. 5, (1996).
- [5] J. Mees, *et al.* "Open Structure Integrated Schottky Receiver for Space Applications", *Proc. 20th ESTEC Antenna Workshop on Millimeter Wave Antenna Technology and Antenna Measurements*, ESA/ESTEC, Noordwijk, June, 1997.

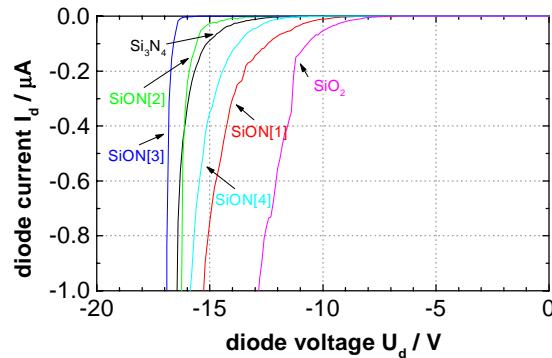

Figure 1: Comparison of the breakdown voltage with varying composition in the passivation layer.

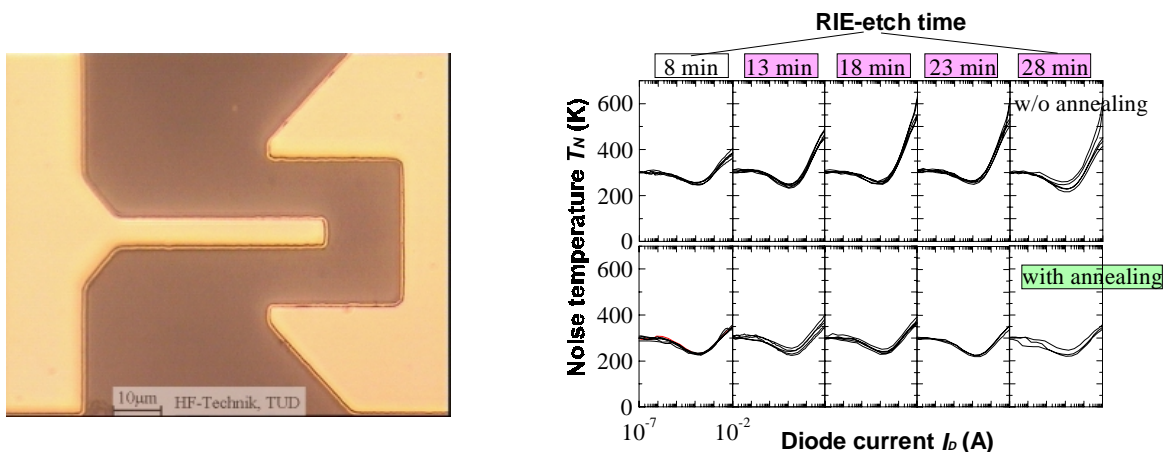
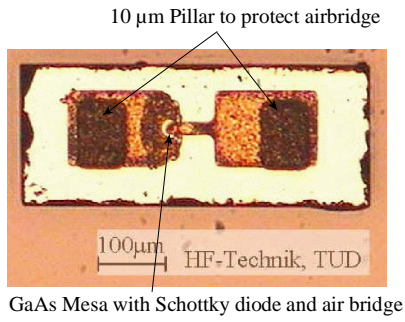

Figure 2: Test structure showing the air-bridge shape from the bottom. The top seen layer is the bottom Ni layer of the seed layer. Undercutting is about 1 μ m.

Figure 3: Measured effective noise temperatures of the diodes whose anode openings were with/without thermal treatment after the different RIE-etch times. 12 minutes RIE etching was expected to exactly open through the passivation layer.



GaAs Mesa with Schottky diode and air bridge

(a)

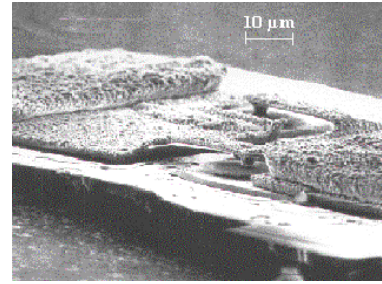

(b)

Figure 4: a) Single planar varactor diode b) Planar anti-parallel mixer diode pair

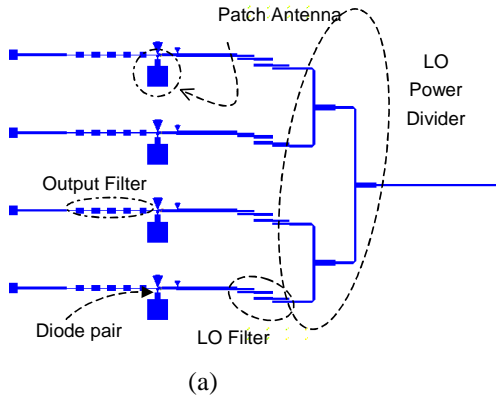

(a)

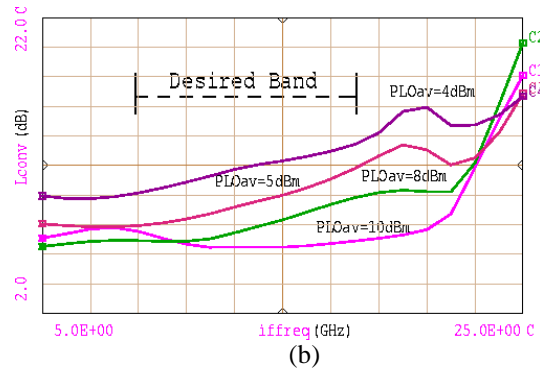

(b)

Figure 5: a) Layout of 4-receiver array b) Simulated conversion loss for different pumping power level

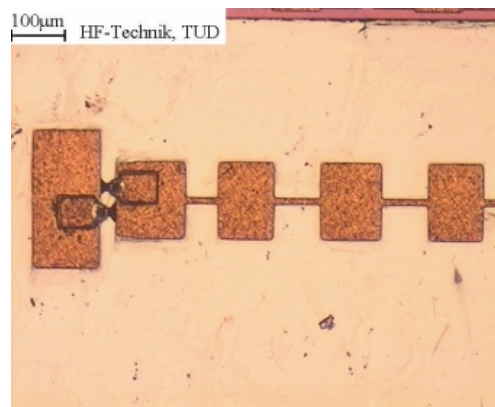

Figure 6: Planar anti-parallel mixer diode pair integrated with rf-filter on GaAs-substrate

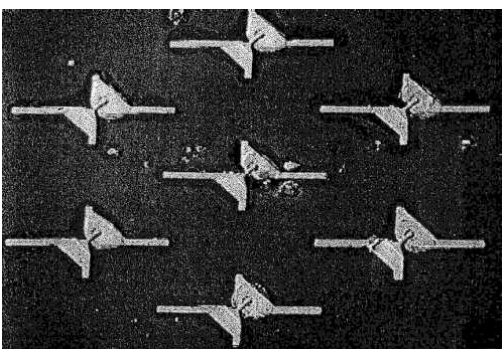

Figure 7: Quasi-optic frequency multiplier using a Schottky diode array with 7 diodes integrated with crossed dipole antennas

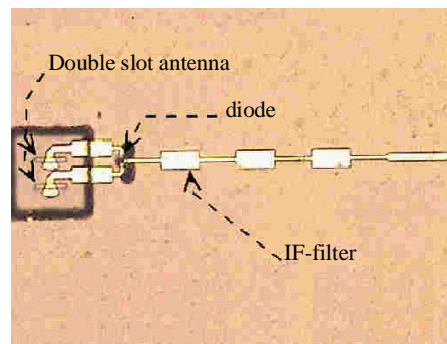

Figure 8: A prototype of a monolithically integrated quasi-optic receiver using the microstrip technique