

Identification of a Strongly Nonlinear Device Compact Model Based on Vectorial Large Signal Measurements

M. Camprini¹, A. Cidronali¹, C. Accillaro¹, I. Magrini¹, G. Loglio¹,
G. Collodi¹, J. Jargon², G. Manes¹

¹Department of Electronics and Telecommunications, University of Florence, V. S. Marta 3, 50139 Florence, Italy

²National Institute of Standards and Technology, Boulder, CO 80305 U.S.A.

Abstract - This paper deals with the identification of equivalent circuit models for strongly nonlinear devices by taking advantage of the so-called “Vectorial Large-Signal Measurements”. A very specific device, the Heterojunction Interband Tunneling FET (HITFET), has been selected as case of study for its peculiar nonlinear behavior. A comprehensive description of the identification is given along with a number of experimental results. In particular, the comparison between simulated and measured data for different power levels and frequencies from the set adopted during the identification confirms the extrapolation capability of the approach.

I. INTRODUCTION

Modeling of microwave devices and circuits has seen a continuous effort aimed to follow the huge technological development. Among the various solutions available in literature, behavioral modeling and compact modeling are the most developed approaches due to their characteristics of effectiveness and easiness of implementation in a conventional CAD environment. In a behavioral model the description is generally provided in terms of state functions, which are commonly determined processing small-signal and DC measurements. Recently new techniques based on Vectorial Large Signal (VLS) measurements have been proposed to identify and validate such class of models [1],[2]. These models, in order to provide a meaningful interpolative capability, must be identified in a broad range of possible device functional states and usually their predictive capability is matter of concerns. Compact model approaches are based on the definition of an equivalent circuit. They represent a valid solution when the device physics is sufficiently simple or sufficiently understood to allow its translation in terms of controlled charge and current sources. In this case the identification process does not follow an established protocol, anyway, once the compact model parameters are successfully extracted, the model validity range can be extended to a wide range of functional states. This paper is aimed to demonstrate how the additional information deriving from VLS measurements can be used in the field of equivalent circuit model identification for strongly nonlinear devices. A device able to exhibit a very peculiar characteristic, the Resonant Interband Tunneling Diode, has been chosen as a case of study. The identification procedure is presented along with several experimental results in order to provide the potentialities of the technique.

II. THE QUANTUM MICROWAVE MONOLITHIC INTEGRATED CIRCUIT TECHNOLOGY

The device technology adopted in this paper has been developed for low-power microwave applications [3]-[5], whose description is beyond the aim of this paper.

The Heterojunction Interband Tunneling FET (HITFET) is a three terminal device obtained by integrating a Heterojunction Interband Tunneling Diode (HITD) on the Drain of a conventional p-HEMT as shown in Figure 1.

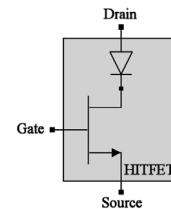

Fig.1: HITFET schematic.

The typical Current–Voltage characteristics of a HITFET in a common Source configuration is shown in Figure 2. The properties of the device depend on the ratio between the FET’s saturation current I_{sat} and the diode’s peak current I_p . If, due to the scaling and biasing of the devices, I_{sat} is significantly higher than I_p , then the HITFET’s Drain current is limited by the diode and the embedded P-HEMT acts as a series load controlled by the DC voltage applied to the Gate terminal. In these conditions the HITFET can be used as a ‘voltage controlled’ tunneling device (see [4] for more details). The opposite situation is obtained when $I_{sat} < I_p$; in this case the Drain DC current is limited by the HEMT and the behavior of the device is similar to that of a simple transistor.

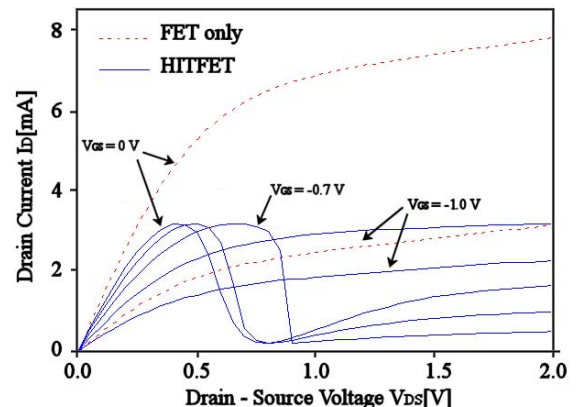

Fig.2: HITFET’s and HEMT’s I/V characteristics.

As shown in Fig. 2, by properly setting the Gate to Source bias Voltage V_{GS} it is possible to switch between the two different operating modes described above.

III. HITFET VECTORIAL LARGE SIGNAL CHARACTERIZATION

In order to show the HITFET's large-signal properties, the device has been characterized using a Non Linear Network Analyzer (NVNA). The NVNA consists of a 4-channel data acquisition system which provides magnitude and phase values of the incident and reflected waves at both ports of the device on a user-defined grid [6]. The measurement setup is represented in Figure 3; a large signal is applied to the DUT using only the port 2 of the NVNA, being port 1 properly termed. An appropriate amplitude and phase calibration procedure allows the correction of the "raw" quantities. The NVNA is able to measure the voltage and current waveforms of the HITFET as a function of the frequency and power level injected by the source 'SYNTH' shown in Fig.3. In the following these two quantities will be respectively termed as V_M and I_M . The fundamental assumption at the basis of the feasibility of the characterization is that the HITFET is stable once connected to the NVNA port and biased in the NDR region. This may not be always true, but with a proper selection of the HITFET characteristic this constriction can be achieved [4].

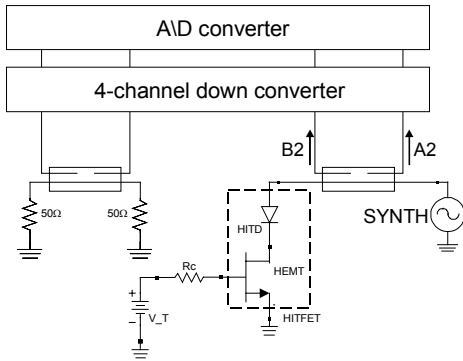

Fig.3: NVNA set up adopted for the HITFET's characterization (the bias part of the set is not shown).

The I/V characteristic of the selected device, which is based on a 3.5 mA peak-current HITD, is reported in Figure 4.

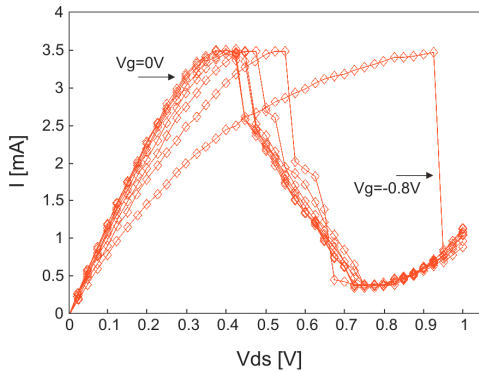

Fig. 4: HITFET's I/V characteristic for V_{GS} spanning from 0 to -0.8V in 100 mV steps (b).

The right shift observed in the static I/V curve as V_{GS} is decreased from 0 V to -0.8 V is due to the increasing HEMT's channel resistance.

Large signal characterization has been carried out by applying a RF signal on the Drain terminal of a HITFET in various bias conditions. The frequency f_{RF} of the injected signal is either 1 GHz or 2 GHz, while the power level P_{RF} spans from -25 dBm to 0 dBm.

The dynamic behavior of the device can be reproduced by plotting in the I_{ds} , V_{ds} plane the curves corresponding to the various sets of measurement parameters (V_{DS} , V_{GS} , f_{RF} , P_{RF}). As an example, in Figure 4 the curves obtained with $V_{DS}=0.65$ V, $f_{RF}=1$ GHz and $P_{RF}=0$ dBm are reported for two different values of the Gate to Source bias voltage. When V_{GS} is set to 0 V the device is in the diode-like mode; while the second plot, obtained for $V_{GS}=-1.0$ V, reproduces the typical curve produced by a HITFET operating in the transistor mode.

The hysteresis-like behavior that can be observed is due to the reactive component associated to the device and the increase of the trajectory width is both related to the capacitance non linearity and the harmonics growth. Finally, the amplitude of the trajectory is associated both to the dissipated power and to the HITFET's I/V characteristic.

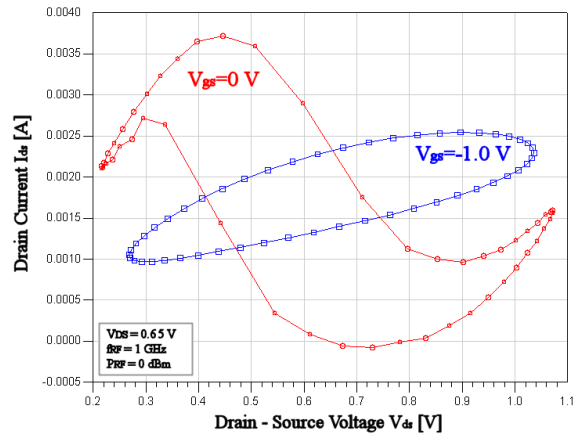

Fig. 5: I/V plane at the HITFET's drain, pumped by a 1GHz, 0dBm signal. Drain Bias voltage $V_{DS}=0.65$ V.

IV. HITFET NON LINEAR MODEL: EXTRACTION OF EQUIVALENT CIRCUIT PARAMETERS

If the Gate to Source bias voltage V_{GS} applied to the HITFET spans in a range between +0.2 V and -0.6 V, by comparing the DC characteristics of the HITFET and the embedded HEMT, it can be easily demonstrated that the transistor works in the VVR region for any value of V_{DS} applied to the Drain of the HITFET. This happens because the HEMT's saturation current (~ 20 mA for $V_{GS}=0$ V) is about one order of magnitude higher than the HITD peak current (~ 3.5 mA). Within the range of V_{GS} values that forces the HEMT in the VVR region, the HEMT itself can be considered as a linear passive load. In these bias conditions the non-linearity of the device is associated only to the diode and the HITFET's equivalent non-linear circuit is the one shown in Fig. 6.

This assumption is no longer valid if the HITFET is biased at lower V_{GS} voltages (even if the device still operates in the diode-like mode), since in this case the saturation current becomes comparable to the diode peak current and the HEMT is no longer forced to work in the VVR region.

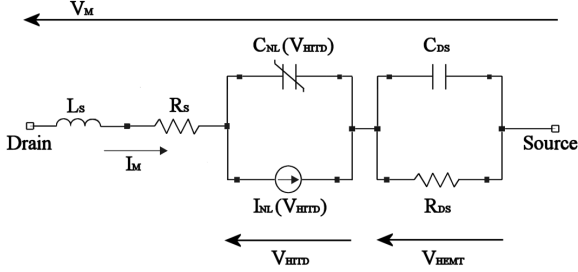

Fig. 6: HITFET's non linear equivalent circuit.

The series inductance L_S is related to the reactive behavior of metallizations, while R_S takes into account the series resistance produced by the interconnections and the ohmic contacts of the two devices. The equivalent admittance of the HEMT's channel is reproduced by R_{DS} and C_{DS} , whose value is set by the Gate bias voltage V_{GS} . In the time domain the behavior of the circuit is described by the following system of differential equations:

$$\begin{aligned} V_M &= R_S \cdot I_M + L_S \cdot \frac{d}{dt} I_M + V_{HITD} + V_{HEMT} \\ I_M &= \frac{1}{R_{DS}} V_{HEMT} + C_{DS} \cdot \frac{d}{dt} V_{HEMT} \\ I_M &= I_{NL}(V_{HITD}) + \frac{d}{dt} [Q_{NL}(V_{HITD})] \end{aligned} \quad (1)$$

where:

$$\frac{d}{dt} Q_{NL} = \frac{d}{dV_{HITD}} Q_{NL} \cdot \frac{d}{dt} V_{HITD} = C_{NL} \cdot \frac{d}{dt} V_{HITD} \quad (2)$$

In order to define the HITD non-linear current source $I_{NL}(V_{HITD})$ and the HITD non-linear capacitance $C_{NL}(V_{HITD})$, the linear part of the circuit has to be de-embedded from the measured data (V_M and I_M). In other words, the non linear part of the circuit can be characterized only once the relation between I_M and V_{HITD} has been found. Considering that, due to the different dimensions of the two devices [4], the only layout difference between the HITFET and the HEMT is the presence of the HITD on the Drain microstrip line, the easiest way to characterize the linear part of the circuit is to extract L_S , R_{DS} and C_{DS} from the high-frequency behavior of the HEMT's scattering parameters and then calculate the value of R_S from the HITFET's small signal measures.

After the linear part of the circuit has been dimensioned, the non linear current source I_{NL} can be evaluated from the measured static I/V characteristic of the device. Since in DC measurements there is no contribution from reactive elements (L_S , C_{NL} and C_{DS}), the current is due only to the non-linear current source and parasitic resistor. The relation between I_{NL} and

V_{HITD} is therefore easily determined by de-embedding from the measured static voltage the contribution added by R_S and R_{DS} . Once the non linear current source $I_{NL}(V_{HITD})$ is known, the non linear capacitance $C_{NL}(V_{HITD})$ can be extracted from large-signal measures considering that:

$$\frac{d}{dt} Q_{NL}(V_{HITD}) = C_{NL}(V_{HITD}) \cdot \frac{d}{dt} V_{HITD} = I_M - I_{NL} \quad (3)$$

which then leads to the following equation:

$$C_{NL}(V_{HITD}) = (I_M - I_{NL}) / \frac{d}{dt} V_{HITD} \quad (4)$$

Since at this point I_{NL} and V_{HITD} have already been extracted, $C_{NL}(V_{HITD})$ can be calculated evaluating (4) over a time interval corresponding to half a period and starting from a peak of $V_{HITD}(t)$. This step is required in order to avoid incurring in an undefined condition due to a null first order derivative of $V_{HITD}(t)$.

V. MODEL VALIDATION

The procedure described in the previous paragraph has been carried out on the measured data obtained by applying a 1GHz, 0 dBm signal to the Drain a HITFET biased at $V_{DS}=0.65$ V, $V_{GS}=0$ V. The results in terms of the non-linear capacitance $C_{NL}(V_{HITD})$ are shown in Figure 7.

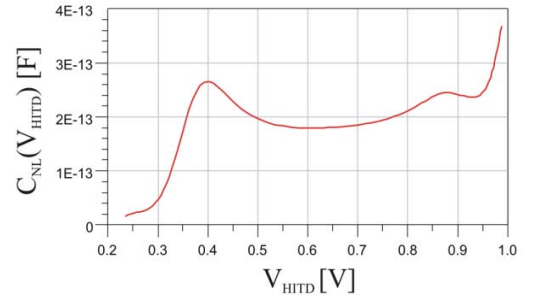

Fig. 7: HITD's non linear Capacitance.

The model can be then validated comparing simulated and measured data when a signal with a different frequency or power level is applied.

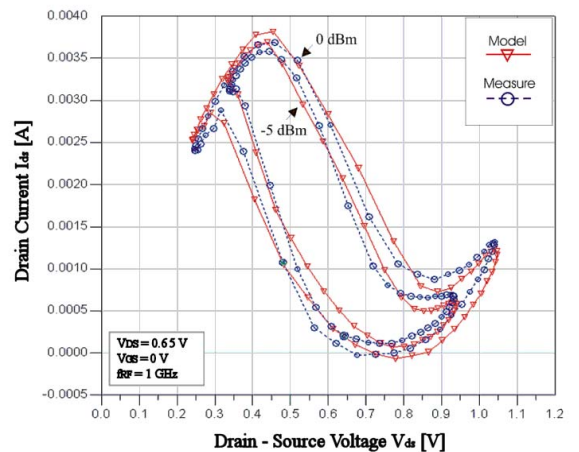

Fig. 8: I/V plane at the HITFET's drain, pumped by a 1 GHz signal. Bias voltage $V_{DS}=0.65$ V; $V_{GS}=0$ V.

The results are shown in Figures 8 and 9 by plotting in the I_{ds} , V_{ds} plane the curves obtained by injecting respectively a 1GHz signal and a 2GHz signal with two different power levels.

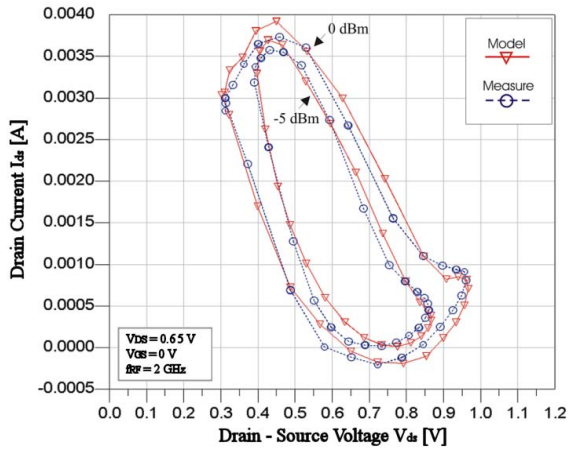

Fig. 9: I/V plane at the HITFET's drain, pumped by a 2 GHz signal. Bias voltage $V_{DS}=0.65V$; $V_{GS}=0V$.

As explained in the previous paragraph, if V_{GS} is decreased below $-0.6 V$ the embedded p-HEMT is no longer operating in a linear mode. In these bias conditions the behavior of the device can be reproduced only using non-linear models for both the HITD and the HEMT. In figure 10 the measured curve corresponding to $V_{DS}=0.65 V$, $V_{GS}=-1.0 V$, $f_{RF}=1GHz$ and $P_{RF}=0 dBm$ is compared to the simulated data produced by a full non-linear model obtained by substituting R_{DS} and C_{DS} with a conventional large signal p-HEMT model. This second model, which has been previously developed for other purposes, is able to describe the behavior near the pinch off-region of a transistor similar to the one embedded within the HITFET. The good agreement between the two curves is a further validation of the HITD's non linear model extraction procedure described above.

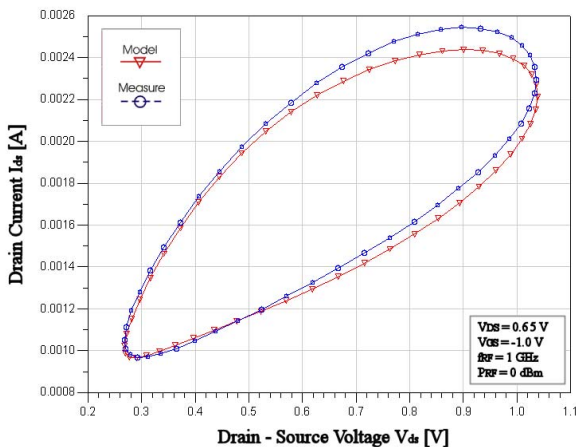

Fig. 10: I/V plane at the HITFET's drain, pumped by a 1GHz signal. Bias voltage $V_{DS}=0.65V$; $V_{GS}=-1.0V$.

VI. CONCLUSION

In this paper a procedure for extracting the equivalent circuit of a strongly non-linear device from NVNA

measurements has been introduced. It is worth to point out that, to the best of our knowledge, as far as today no physical-based analytical description of the non-linear HITD capacitance has been proposed. Considering that, the method proposed in this paper also provides a meaningful insight on the device physics. The comparison between measured and simulated trajectories, in particular the ones shown in Fig. 9 and 10, confirms the extrapolation capability of the approach.

ACKNOWLEDGMENTS

The authors want to acknowledge the technical support of the Motorola Physical Sciences Lab, Tempe (AZ), in the realization and development of the devices presented in this paper. Research reported here was performed in the context of the network TARGET – “Top Amplifier Research Groups in a European Team” and supported by the information Society Technologies Programme of the EU under contract IST-1-507893-NOE, www.target-org.net.

REFERENCES

- [1] D. M. Schreurs, J. Verspecht, S. Vandenberghe and E. Vandamme, “Straightforward and Accurate Nonlinear Device Model Parameter-Estimation Method Based on Vectorial Large-Signal Measurements”, *IEEE Trans. On Microwave Theory and Tech.*, vol. 50, no. 10, pp 2315-2319, Oct. 2002.
- [2] D. Root, S. Fan and J. Meyer, “Technology Independent Large Signal non Quasistatic FET Models by Direct Construction from Automatically Characterized Device Data”, *1991 European Microwave Week Conference Proceedings*, pp. 927-932.
- [3] A. Cidronali, G. Collodi, M. Camprini, V. Nair, G. Manes, J. Lewis and H. Goronkin, “Ultra Low-Power VCO Based On InP-Hemt And Heterojunction Interband Tunnel Diode For Wireless Applications”, *IEEE Trans. on Microwave Theory and Tech.*, vol. 50, no. 12, pp. 2938-2946, Dec. 2002
- [4] A. Cidronali, V. Nair, G. Collodi, J. Lewis, M. Camprini, G. Manes and H. Goronkin, “MMIC Applications of Heterstructure Interband Tunnel Devices”, *IEEE Trans. On Microwave Theory and Tech.*, vol. 51, no. 4, pp. 1351-1367, Apr. 2003.
- [5] M. Camprini, I. Magrini, G. Collodi, A. Cidronali, V. Nair, G. Manes, A Hybrid Self-Oscillating Mixer Based on InP Heterojunction Interband Tunnel HEMT for Wireless Applications, *2003 European Microwave Week Conference Proceedings*, pp. 205-208.
- [6] E J. Verspecht and P. Van Esch, “Accurately characterizing of hard nonlinear behaviour of microwave components by the Nonlinear Network Measurement System: introducing the nonlinear scattering function”, Proc. Int. Workshop on *Integrated Nonlinear Microwave and Millimeterwave Circuits*, (Duisburg, Germany), 10-11 October, 1996, pp. 17-26.