



Development and scale-up of
technologies for wastewater treat-
ment and reuse in Mediterranean
African countries: the MADFORWATER
project

Ed. by Roberta Lamaddalena and Dario Frascari

Contributors: ROBERTA LAMADDALENA, DARIO FRASCARI, NICO-
LAS KALOGERAKIS, STATHIS KYRIACOU, AHMED RASHED, ATEF
JAOUANI, AMEUR CHERIF, REDOUANE CHOUKR-ALLAH, SARA BO-
RIN, CATHERINE GIBERT, JOCHEN FROEBRICH, NICOLA LAMADDA-
LENA, WEN-TAO LI, BRUNO MOLLE, CONSUELO VARELA ORTEGA,
MARIJN MULDER, PHILIPPE CORVINI, MOHAMED ALHAMDJ,
VITO FELICE URICCHIO

ALMA MATER STUDIORUM - UNIVERSITY OF BOLOGNA
WATER RESEARCH INSTITUTE - NATIONAL COUNCIL OF
RESEARCH BARI 2020

MADFORWATER - DEVELOPMENT AND APPLICATION OF INTEGRATED TECHNOLOGICAL AND MANAGEMENT SOLUTIONS FOR WASTEWATER TREATMENT AND EFFICIENT REUSE IN AGRICULTURE TAILORED TO THE NEEDS OF MEDITERRANEAN AFRICAN COUNTRIES

Copyright to the Authors

This work is distributed under a Creative Commons - Attribution - 4.0 license <https://creativecommons.org/licenses/by/4.0/>

Editors: Alma Mater Studiorum - University of Bologna, Bologna 2020 and Water Research Institute - National Council of Research, Bari 2020

DOI: <http://doi.org/10.6092/unibo/amsacta/6560>.
ISBN: 9788854970380

Cite as: Lamaddalena R., Frascari D. (Eds.), Development and scale-up of technologies for wastewater treatment and reuse in Mediterranean African countries: the MADFORWATER project, University of Bologna, Bologna and Water Research Institute - National Council of Research, Bari, 2020. DOI: 10.6092/unibo/amsacta/6560. ISBN: 9788854970380.

This project has received funding from the European Union's Horizon 2020 research and innovation programme under grant agreement No. 688320.

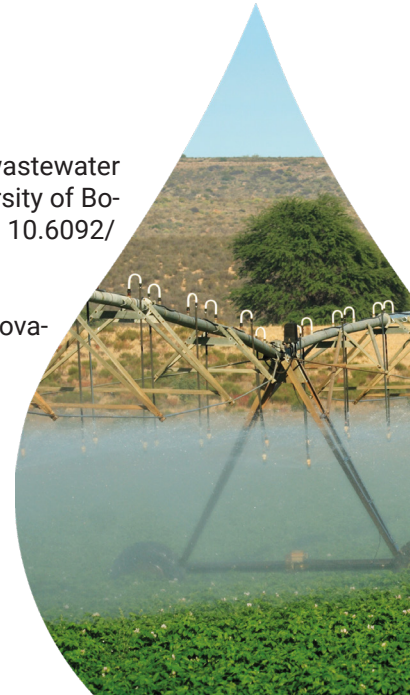

Content

ABBREVIATION.....	4	4 - An innovative approach for the treatment of fruit and vegetable packaging wastewater.....	34
1. INTRODUCTION.....	5	5 - A sustainable approach for the treatment and valorization of Drainage Canal Water.....	40
2. CURRENT SITUATION OF WASTEWATER TREATMENT, WASTEWATER REUSE, IRRIGATION, AND WATER MANAGEMENT IN EGYPT, MOROCCO, AND TUNISIA.....	8	7. IRRIGATION TECHNOLOGIES DEVELOPED BY THE MADFORWATER PROJECT.....	43
3. BACKGROUND INFORMATION ON THE MADFORWATER PROJET.....	9	1 - An efficient low-pressure anti-drift micro sprinkler adapted to treated wastewater.....	43
4. GOALS AND CONCEPT.....	10	2 - An irrigation emitter resistant to clogging	45
5. THE CONSORTIUM.....	14	3 - A consolidated model to optimize irrigation with water of different qualities.....	47
6. WASTEWATER TREATMENT TECHNOLOGIES DEVELOPED BY THE MADFORWATER PROJECT	15	4 - Innovative biofertilizers for a sustainable agriculture in North African Countries.....	49
1 - Innovative approaches for the treatment of municipal wastewater.....	15	5 - Increasing the efficiency of traditional surface irrigation systems in Egypt.....	51
2 - An innovative approach for the treatment and valorization of olive mill wastewater.....	22	8. THE MADFORWATER PILOT PLANTS OF INTEGRATED WASTEWATER TREATMENT AND AGRICULTURAL REUSE.....	52
3 - Innovative treatment trains for the treatment of textile wastewater.....	28		

Abbreviations

BOD = Biological Oxygen Demand
CHCW = Cascade Hybrid Constructed Wetland
COD = Chemical O demand
CW = Constructed Wetland
CWP = Crop Water Productivity
DCW = Drainage Canal Water
DM = Dry matter
DO = Dissolved oxygen
DU = Distribution Uniformity
EC = Electrical Conductivity
EU = European Union
FAO = Food and Agriculture Organization
FBCW = Floating Bed Constructed Wetland
FC = Fecal Coliforms
FDA = Fluoresceine Diacetate Hydrolysis Activity
FW = Fresh Water
FWS = Free Water Surface
GBSW = Gravel Bed Subsurface Wetland
HCW = Hybrid Constructed Wetlands
HRT = Hydraulic Retention Time
M4W = MAD4WATER
MAC = Mediterranean African Countries

MENA = Middle East and North Africa
MPN = Most probable number (MPN)
MWW = Municipal Wastewater
MWW = Municipal Wastewater
MWWTP = Municipal Wastewater Treatment Plant
NTK= Total Kjeldahl Nitrogen
PGPB = Plant growth-promoting bacteria
PP = Pilot Plant
RDCW = Raw Drainage Canal Water
Semi-TDCW = Semi-Treated Drainage Canal Water
SHCW = Sequenced Hybrid Constructed Wetland
SIM = Safe Irrigation Management
SM = Suspended Matter
SP = Sampling Point
TC = Total Coliforms
TDCWT = Reated Drainage Canal Water
TMWW = Treated Municipal Wastewater
TN = Total Nitrogen
TOC = Total Organic Carbon
TP = Total Phosphorus
TSS = Total Suspended Solids
TTWW = Treated Textile Wastewater
TWW = Textile Wastewater
WP = Work Packages
WW = Wastewater

Introduction

Water is a vital resource, a primary element for humans and an essential source for the survival and development of any productive sector. It is a responsibility for everyone, as well as for institutions, to defend, protect and preserve water as the essence of life and the security for future generations. Hence arises the modern setting of water management in agriculture, based on stringent criteria of efficiency and environmental protection, required also by the EU and national legislation. The threat of climate change, the effects of which have an impact on the water cycle and are particularly evident in the Mediterranean area, requires an integrated approach to water management and policies. It is therefore necessary to ensure policies based on governance models compatible with various demands of use, taking into account the trends of water consumption and availability. Water covers 70% of our planet, and it is easy to think that it will always be plentiful. However freshwater - the stuff we drink, bathe in, irrigate our farm

fields with — is incredibly rare. Only 3% of the world's water is freshwater, and two-thirds of that is tucked away in frozen glaciers or otherwise unavailable for our use. Two and a half billion people still lack access to water sanitation facilities; 3 billion people are expected to suffer from water scarcity by 2050, and by 2030 a 40% gap is projected to develop between sustainable water supplies and water withdrawals. An estimated 20% of the world's aquifers are over-exploited. The limit of sustainability in water abstraction has been exceeded for about one-third of the human population. Eutrophication is expected to increase almost everywhere until 2030. Climate change will exacerbate the water crisis, as a result of variations in the distribution and availability of water resources. Agriculture is highly sensitive to water availability and quality, as it accounts for 70% of the world's freshwater withdrawals. Agriculture faces the challenge of producing 100% more food by 2050, but at the same time the bio-economy will require an increased production of no-food agroproducts. The consequences of water scarcity and poor quality are particularly relevant in the Middle East and North Africa (MENA) region.

According to the Global Risk 2015 Report of the World Economic Forum, the water crisis represents by far the greatest risk in the MENA region, where the expected population growth combined with economic growth is projected to result in a 47% increase in water demand by 2035. MENA is the driest region of the world, with water withdrawals exceeding renewable water resources by 30%.

The region is significantly affected by desertification, groundwater overexploitation, seawater intrusion into aquifers, and water quality deterioration. In 2010, the annual renewable water resources in MENA countries (525 m³ /capita, as an average) were about half the 1000 m³ /capita threshold for water scarcity and just above the 500 m³ /capita threshold for absolute water scarcity. Water scarcity curbs socioeconomic development, particularly in agriculture, which utilizes 86% of water withdrawals in the MENA region.

The extent of wastewater (WW) treatment is still low in this region (43%, as an average). In addition, treated WW is typically characterized by insufficient removal of the main pollutants, due to lack of tertiary treatments, poor maintenance and monitoring,

frequent power outages, low qualification of personnel, and undersizing of treatment plants. . In the MENA region, climate change is expected to decrease precipitation and soil moisture and increase evaporation from surface waters and crop water requirement. These changes, combined with population growth, are expected to decrease annual renewable water resources to 414 m³ /capita by 2025. Among several possible strategies to fight the water crisis, the reuse of treated WW represents a promising and widely studied one: it provides a reliable supply of water during regional shortages, it enhances local economic growth, it reduces water withdrawal from aquifers and rivers, it decreases fertilizer consumption in agriculture, and it reduces eutrophication. Unfortunately, few MENA countries implemented substantial WW reuse programs. Several international research projects aim to decrease water stress in the Mediterranean-African region.

water stress in the Mediterranean-African region. The MADFORWATER project aims to developing an integrated set of technological and management instruments for the enhancement of wastewater treatment, treated wastewater reuse for irrigation, and water efficiency in agriculture. MADFORWATER focuses its activities on selected hydrological basins located in 3 Mediterranean-African countries (MACs): Egypt, Morocco, and Tunisia. These countries are representative of the Mediterranean-African region in relation to their population (74% of the region's inhabitants), GDP (64%), produced WW (88%), rate of WW treatment (50%), and hydrological characteristics. The selected countries are characterized by a relevant water scarcity: the annual renewable water resources are equal to 60% of the of 1000 m³ /y threshold for water-stressed areas, and just 7% of produced WW is currently reused.

The aim of MADFORWATER was to develop a set of integrated technological and management solutions to enhance wastewater treatment, reuse for irrigation and water efficiency in agriculture in Tunisia, Morocco and Egypt.

MADFORWATER developed and adapted to three main hydrological basins in the selected MACs technologies for the production of irrigation-quality water from drainage canals, municipal, agro-industrial and industrial wastewaters, and technologies for water efficiency and reuse in agriculture, initially validated at laboratory scale. Selected technologies were further adapted and validated in four field pilot plants of integrated wastewater treatment/reuse. Integrated strategies for wastewater treatment and reuse targeted to the selected basins were developed, and guidelines for the development of integrated water management strategies in other basins of the three target MACs were produced, considering climate change, population increase and economic growth scenarios. The social and technical suitability of the developed technologies and non-technological instruments in relation to the local context was evaluated with the participation of MAC stakeholders and partners. Guidelines on economic instruments and policies for the effective implementation of the proposed water management solutions in the target MACs were developed.

The MADFORWATER consortium consists of 17 partners, 5 of which from the North Africa and 1 from China.

For further information on the project, visit the website: www.madforwater.eu or contact us: dario.

2. Current situation of wastewater treatment, wastewater reuse, irrigation and water management in Egypt, Morocco and Tunisia

In terms of WW treatment, the ratio of treated WW to produced WW is equal to 57% in Egypt and 24% in Morocco, whereas a relatively advanced situation is observed in Tunisia, with a 79% ratio. In all 3 countries, a large fraction of the treated WW (75%–90%) undergoes secondary treatment for biological oxygen demand (BOD) removal, whereas the remaining fraction is subjected only to primary treatment.

Tertiary treatments are rarely implemented. The main technologies utilized for secondary treatment are activated sludge in Tunisia and Egypt and lagoons in Morocco. The main operational problems associated with WW treatment in these countries include the following: 1) insufficient aeration in the secondary treatment, due to power outages or excessive cost of energy; 2) strong delays and high costs for the purchase of components for repairing equipment; 3) failures of the secondary process due to the presence of toxic compounds carried by untreated industrial WWs; 4) WW treatment plants operating above their capacity, due to rapid population growth; and 5) insufficient monitoring of treated WW quality due to legal or technical constraints. The type and diffusion of irrigation technologies are quite diverse in the 3 examined countries: in Egypt 98% of the cultivated area is equipped with irrigation, whereas in Morocco and Tunisia this fraction is equal to just 16% and 10%, respectively. Surface irrigation systems, such as furrow, border strip, and basin irrigation, represent

the most common irrigation technology, with an average efficiency equal to 60%. Conversely, localized irrigation systems are not commonly used in these countries: drip irrigation (90% field efficiency) is used in 20% of the irrigated area (average of the 3 countries), and sprinkler irrigation (75% efficiency) is used in just 14% of the irrigated surface. Both Morocco and Tunisia have significantly subsidized the supply of drip irrigation systems. However, because of poor maintenance and low equipment quality, most of these systems were clogged or inefficient after 1 to 2 y, and the farmers switched back to surface irrigation. The treated WW reused for irrigation is equal to 0.3% of WW produced in Morocco, 4% in Egypt, and 24% in Tunisia. The fraction of the total irrigation area equipped for irrigation with treated WW varies between 1% and 2%. The constraints leading to these poor levels of WW reuse are lack of social acceptance due to inadequate information on the benefits of this practice and to the poor monitoring of treated WW, incomplete economic analysis of WW reuse options, mismatch between water pricing and water scarcity, and lack of economic incentives

for treated WW reuse. Each of the 3 target MACs made significant progress in the field of sustainable water management in the last 2 decades. However, further advancement is needed to develop water management strategies capable of 1) guiding local governments, basin authorities, WWTP managers, and farmers in the selection of the most effective water treatment and irrigation technologies, and 2) defining economic instruments aimed at enhancing the adoption of effective water treatment and irrigation technologies and the reuse of treated WW. In all 3 countries, the national legislation imposes limits for the agricultural reuse of treated WW.

3. Background information on the MADFORWATER project

Title: DevelopMent AnD application of integrated technological and management solutions FOR wasteWATER treatment and efficient reuse in agriculture tailored to the needs of Mediterranean African Countries

Acronym: MADFORWATER

Type: research and innovation project

Project coordinator: Alma Mater Studiorum – Università di Bologna

Partners involved: 17 partners distributed over 6 EU countries, 3 selected Mediterranean African Countries (MACs), Switzerland and China

Funding: Horizon 2020 WATER-5c-2015

Duration: June 1, 2016 - November 30, 2020

The MADFORWATER project aims at achieving the goals of the EU Horizon 2020 call for action topic WATER-5c-2015, by focusing on the development of technological and non-technological solutions for the management of water resources in Tunisia, Morocco and Egypt. The partners of the MADFORWATER project are involved in developing and tailoring technological and management solutions focused on wastewater treatment and efficient reuse in agriculture in North Africa. The new technologies developed, that have been adapted to the social and technical context of the three countries involved, are aimed at producing irrigation-quality water from municipal and industrial wastewaters, as well as from drainage canals. In parallel, the MADFORWATER project

developed new technologies for water efficiency and reuse in agriculture. A tight collaboration with local players and stakeholders helped to adequately tailor the proposed solutions to the local context. The MADFORWATER project aims at producing a relevant and long-term impact in Egypt, Morocco and Tunisia in terms of wastewater treatment and reuse, thus improving agricultural production as well as decreasing exploitation of water reserves and water pollution.

4. Goals and concept

The general objective of MADFORWATER is to develop an integrated set of technological and management instruments for the enhancement of wastewater treatment, treated wastewater reuse for irrigation and water efficiency in agriculture, with the final aim to reduce water vulnerability in selected basins in Egypt, Morocco and Tunisia. MADFORWATER tackled the integration of the supply (wastewater treatment) and demand (water reuse in agriculture) sides and

the consequent adaptation of the proposed solutions to the local context through:

1. The installation and optimization of four field pilot plants of integrated wastewater treatment and efficient reuse in agriculture;
2. A participatory and multidisciplinary approach for the design of technologies and management solutions, attained by means of an international cooperation framework characterized by a consolidated collaboration between EU and Mediterranean African Countries (MAC) partners;
3. A strong dialogue between the consortium and numerous MAC and international stakeholders involved in the Stakeholder Advisory Board, to maximize the suitability of the proposed solutions in relation to the local context, and therefore the expected long-term impact of the MADFORWATER technologies, water management strategies and policies.

The overall goal of MADFORWATER was translated into the following specific objectives: 1) Improving the identification of vulnerabilities in terms of water quantity and quality in Egypt, Morocco, and Tunisia and developing a locally adapted water vulnerability as-

essment tool to be used for the evaluation of the potential effectiveness of basin-scale water management strategies. 2) Developing and/or adapting to the local context technologies for WW treatment, treated WW reuse for irrigation, and efficient water use in agriculture. 3) Developing basin-scale water and land management strategies, closely related to the project's technologies. 4) Increasing the level of capacity building in the target countries in relation to the proposed solutions and the social acceptance of treated WW reuse in agriculture. The achievement of these MADFORWATER goals is based on 2 pillars: **WW treatment**, selected as a valuable water source for agriculture, and **irrigation**, which represents the primary source of water demand in MACs. While the first pillar aims to increase the amount of available irrigation-quality water, the second aims to enhance WW reuse for irrigation and the efficiency of water consumption in agriculture while also ensuring an adequate soil health. These 2 pillars are transversally characterized by 2 key concepts: adaptation and integration. A rigorous **adaptation** approach is applied to the development of technologies and management strategies for water and land in order to make them technically and culturally suitable for the environmen-

mental and socioeconomic context of the target MACs. Such an approach includes the strong involvement of relevant MAC stakeholders who regularly provide feedback on the adaptation measures undertaken and on the social acceptance of the proposed solutions. In addition, **integration** is applied in the first place between the 2 pillars by means of a series of demonstration plants where different WW types are treated with MADFORWATER technologies and reused for the irrigation of crops typical of the 3 target countries, using irrigation technologies adapted to the use of treated WW. The integration approach is applied also within each MADFORWATER pillar, with an integrated development of technologies, decision support tools, and management strategies for water and land.

MADFORWATER is articulated in 3 phases, or blocks of activities:

- the **analytical phase**, that produced tools for the analysis of water vulnerabilities related both to the water supply and water demand domains at country-scale and basin-scale;
- the **technological phase**, dedicated to the development and adaptation of technologies for WW

treatment and agricultural reuse; a high number of WW treatment and irrigation technologies were investigated separately at laboratory scale, in order to screen a large number of potential solutions and identify the most promising ones in terms of performances, environmental impact, costs, benefits and adaptation to the local context; then, a selection of the WW treatment and water irrigation technologies were integrated in 4 field pilot plants, thus increasing the scale for technology adaptation and integrating the water supply and water demand domains;

- the **implementation phase**, which included activities to maximize the project's long-term impact, such as water and land management strategies, policy recommendations, capacity building, and industrial exploitation.

This booklet focuses on the presentation of the main results attained by MADFORWATER in the framework of the technological phase. In particular, section 6 presents the results of the development and

adaptation of the WW and irrigation technologies at laboratory scale, whereas section 7 presents the results achieved in the 4 pilot plants of integrated WW treatment and agricultural reuse.

Four categories of WWs, selected on the basis of their quantitative and qualitative significance in the 3 target MACs, were tackled in MADFORWATER, with the aim to produce irrigation-quality water, on the basis of the following rationale:

1. **Municipal WW (MWW)**, that represents 82-92% of the total produced WW in the studied MACs, and which is characterized by a large untreated fraction.
2. **Textile WW (TWW)**, chosen as a relevant type of industrial WW, due to the significance and rapid growth of the textile industry in the 3 target MACs (textile production provides 6% of GDP in Egypt, 7% in Morocco and Tunisia). TWW production is equal to $48 \cdot 10^6 \text{ m}^3/\text{y}$ in Egypt, $2.8 \cdot 10^6 \text{ m}^3/\text{y}$ in Tunisia and $2.7 \cdot 10^6 \text{ m}^3/\text{y}$ in Morocco (5-7% of the total industrial WW produced in the target MACs).
3. **Two agro-industrial WWs** have been selected on the basis of their quantitative and qualitative relevance in all the 3 MACs and of the lack of cost-effective, industrial-scale processes for their treatment:

a. **Olive mill WW (OMWW)**, containing high concentrations of phenols (0.5-18 g/L) and COD (20-70 g/L), and characterized by a high production in the target MACs: Tunisia $1.2 \cdot 10^6 \text{ m}^3/\text{y}$, Morocco $3.5 \cdot 10^5 \text{ m}^3/\text{y}$, Egypt $1.4 \cdot 10^5 \text{ m}^3/\text{y}$. Their high PC content (0.1-18 g/L) is toxic for plants. Thus, although OMWWs have traditionally been discharged directly in the olive tree fields, most countries have recently banned this practice, thus imposing OMWW treatment.

b. **Fruit and vegetable packaging WW (FVPWW)**, produced in the packaging process of all the fruits and vegetables exported by the target MACs. FVPWW represents a concern mainly due to the relevant concentrations of different fungicides, mainly thiabendazole (0.8-1.5 g/L), imazalil (0.25-0.5 g/L), guazatine (0.6-1.2 g/L) and ortho-phenyl phenol (1-1.2 g/L).

4. For Egypt MADFORWATER focused on **drainage canal water (DCW)**, that collects most municipal and industrial WWs produced in the Delta zone. It contains BOD (0.02-0.07 mg/L), COD (0.03-0.12 g/L), NH_3 (0.01-0.03 g/L), heavy metals (Cu, Cr, Ba, Mn, Zn; up to 0.01 g/L), fecal coliforms. $11 \cdot 10^9 \text{ m}^3/\text{y}$ of DCW are used for irrigation in Egypt.

5. The consortium

The MADFORWATER consortium consists of 17 partners geographically distributed mainly around the Mediterranean Sea, in 7 European countries, 3 MACs, and China. It comprises 9 universities, 4 research centers, 1 international no profit organization (FAO), 1 consultant company with expertise in marketing and business plan development, and 2 WW treatment and irrigation companies that designed and constructed the MADFORWATER demonstration plants. The expertise of the MADFORWATER partners are listed in this table:

Partner	Expertise
Alma Mater Studiorum – University of Bologna (Italy)	Project coordination; WW treatment
University of Manouba (Tunisia)	WW treatment; demonstrator pilot operation
Technical University of Crete (Greece)	WW treatment
University of Tunis El Manar (Tunisia)	WW treatment; demonstrator pilot operation
Wageningen Environmental Research (Netherlands)	Water vulnerability analysis; stakeholder involvement
University of Applied Sciences and Arts of Northwestern Switzerland (Switzerland)	WW treatment; water vulnerability analysis; integrated water management, including policies and economic instruments, life cycle analysis of technologies
Agronomic and Veterinary Institute Hassan II (Morocco)	WW treatment; irrigation; demonstrator pilot operation
University of Milan (Italy)	WW treatment; irrigation
FAO Regional Office for Near East and North Africa (International)	Water vulnerability analysis; capacity building
Polytechnic University of Madrid (Spain)	Water vulnerability analysis; integrated water management, including policies and economic instruments
Mediterranean Agronomic Institute of Bari (Italy)	Irrigation; integrated water management, including policies and economic instruments
National Water Research Center - Ministry of Water Resources and Irrigation (Egypt)	WW treatment; demonstrator pilot construction and operation
National Research Institute of Science and Technology for Environment and Agriculture (France)	Irrigation
PNO Innovatieadvies (Netherlands)	Cost benefit analysis of technologies; business plans development; coordination of exploitation and dissemination activities
S.K. Euromarket Ltd (Cyprus)	WW treatment; demonstrator pilot construction
Nanjing University (China)	WW treatment
ROLLAND Atroseurs Sprinklers (France)	Irrigation; demonstrator pilot construction

6. Wastewater treatment technologies developed by the MADFORWATER project

1 - Innovative approaches for the treatment of municipal wastewater

Main pollutants to be removed for an agricultural reuse:

Organic compounds, nitrogen, phosphorous, TSS and pathogens

Technologies mainly used in Egypt, Morocco and Tunisia for the treatment of this wastewater

Most of the municipal wastewater treatment plants located in Tunisia and Egypt use conventional aerobic activated sludge process (at low and medium loads) as secondary treatment. A lower number of plants possess tertiary treatment for N and P removal with aerated lagoons. UV disinfection is used for the tertiary treatment only at pilot scale plants. The main disadvantage of the activated sludge process is the

low efficiency in removing ammonia nitrogen or phosphorous. COD and BOD5 contents of the treated municipal wastewater by the above mentioned processes generally exceeds the limits imposed by the local (e.g., NT 106.03) and ISO standards for the reuse of treated wastewater for irrigation. Moreover, the microbiological content of the treated wastewater presents a health concern if it is used for irrigation in agriculture.

Short presentation of the technologies developed by MADFORWATER for this wastewater

The challenge is to develop a treatment train able to attain high treatment efficiency and reliability, with reduced capital, operation and maintenance costs. MADFORWATER is developing one technique, which consists in nitrifying trickling filters with innovative high specific-surface carriers, for the secondary treatment of municipal wastewater wastewater. As tertiary treatment, two techniques are tested: a) constructed wetlands to remove N, P, heavy metals and emerging pollutants and b) Immobilized enzyme bioreactors for the degradation of emerging pollutants. These technologies are briefly presented in the following tables.

Nitrifying trickling filters with innovative high specific-surface carriers

Specific pollutants targeted by this technology:

Residual BOD, nitrogen, phosphorous, and pathogens

A trickling filter consists of permeable medium made of a bed plastic (of rock or slag) over which wastewater is distributed to trickle through. It also includes a distribution system. A rotary hydraulic distribution is usually standard for this process.

This technology aims to:

- reduce retention times thanks to the attainment of a high biofilm thickness,
- improve the nitrification / denitrification performances.

The lab scale reactor consisted of 4 compartments: a septic tank for primary treatment of MWW, a nitrifying trickling filter configured as a two-stage system (in the first stage, the removal of BOD is accomplished, followed by the second stage where nitrification is achieved), a recirculation tank, and a secondary clarifier for sludge settlement.



Lab scale reactor for municipal wastewater treatment

- (1) Influent inlet, (2) Activated carbon filter, (3) Septic tank, (4) Recirculation tank, (5) Recirculating pump, (6) Water distributor, (7) 1st stage of the trickling filter, (8) 2nd stage of the trickling filter, (9) Secondary clarifier, (10) Effluent outlet

Specific features that make this technology suitable for the context of Egypt, Tunisia and/or Morocco and for the attainment of the ISO 16075 standard for agricultural WW reuse

Trickling filters may be suitable for the target countries thanks to the low maintenance, cheap installation and high stability against fluctuation of hydraulic and organic loads. The operation of a trickling filter has as well the advantage of not requiring an external air supply, which reduces energy consumption, since air is naturally convected through it, due to the temperature difference between its interior and exterior. Moreover, the proposed system combines the secondary and the tertiary treatment allowing the removal of both BOD and ammonia nitrogen, which make it suitable to obtain irrigation quality water.

Results obtained in MADFORWATER

The reactor was operated for a period of 350 days at different HRT 20, 10, 5 and 2 days. During this period, we monitored the following parameters: COD, BOD, ammoniacal nitrogen, nitrite, nitrate and phosphorous. The performance of the reactor at each HRT was evalu-

ated under steady state conditions. Once the system stabilized, the reactor showed satisfactory organic matter removal efficiency, since removal rates of 91 and 92% were achieved for COD and BOD, respectively. The resulted COD and BOD concentrations are in the range of the limits imposed by the Tunisian Standard NT106.03 for wastewater reuse in irrigation (COD<90 mg/L and BOD<30 mg/L).

Under steady state conditions, ammoniacal nitrogen decreased markedly to achieve a concentration of about 0.6 mg/L which is under the limits specified by the new Tunisian regulation published in 2018 (Official Journal of the Tunisian Republic) relating to the discharge within the Public sanitation network. However, the concentration of nitrite and nitrate increased to reach around 0.18 mg/L and 13 mg/L, respectively. The phosphorous concentration decreased markedly from 12.5 mg/L to around 2 mg/L, but still exceed the limits of the Tunisian standards.

The TSS concentration decreased significantly from 354.3 mg/L to around 5.4 mg/L which corresponds to a removal efficiency of 98%. These values satisfy the limits imposed by the Tunisian

standard NT 106.03 in terms of TSS (30 mg/L).

The effluent pH data fluctuated between 7.13 and 7.62, and achieved the Tunisian standard specification value of 6.5–8.5. The average EC value of the effluent was 7.2 mS/cm, which was similar to that observed for the affluent (7.8 mS/cm). The resulted EC values exceed slightly the allowable Tunisian standard NT106.03 specification of 7 mS/cm.

Specific obstacles relative to the application of this technology in Egypt, Tunisia and/or Morocco and to the production of irrigation-quality treated wastewater according to the ISO 16075 standard (max 5 lines)

The average values of the main physicochemical characteristics of the treated municipal wastewater were comparable to those specified by the Tunisian standard NT106-03 for wastewater reuse in irrigation and the new Tunisian regulation published in 2018 (Official Journal of the Tunisian Republic) except for phosphorous and faecal coliform. This technology is considered as secondary treatment and a part of tertiary treatment. Further treatments for pathogen removal should be integrated.

Constructed wetlands

Specific pollutants targeted by this technology:

Heavy metals, HMs (Ni, Cd, Zn) and emerging organic contaminants (EOCs) (bisphenol A, ciprofloxacin, sulfamethoxazole)

Technology description

CWs for wastewater treatment involve the use of engineered systems that are designed and constructed to utilize natural processes. These systems are designed to mimic natural wetland systems, utilizing wetland vegetation, soil, and associated microorganisms to remove contaminants from wastewater effluents. They can achieve multiple goals of contaminant removal such as total suspended solids, biochemical oxygen demand, organic compounds, and inorganic constituents to meet regulatory targets. Horizontal subsurface flow CW mesocosms made from stainless steel, filled with gravel and planted with the Mediterranean halophyte *Juncus acutus* L. is fed with municipal wastewater

polluted with heavy metals and emerging organic contaminants. Specific bacteria inoculants endowed with degrading potential and the ability to promote plant growth can be used to reclaim water in the so-called 'microbial assisted phytodepuration', making the study of CW plant-associated microbiome a priority to gain advanced and exploitable knowledge.

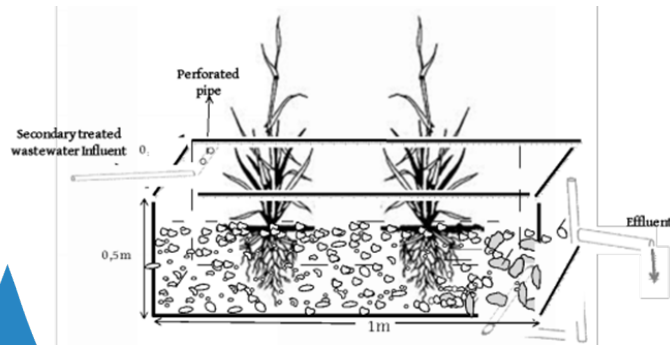

Representation of the horizontal subsurface flow system, for the treatment of municipal wastewater contaminated with EOCs/HMs.

Specific features that make this technology suitable for the context of Egypt, Tunisia and/or Morocco and for the attainment of the ISO 16075 standard for agricultural WW reuse

Constructed wetlands are low cost, low-energy, easily operated and maintained compared to conventional treatment systems, able to achieve contaminants removals to meet regulatory targets and have a strong potential for application in developing countries, particularly by small rural communities. Moreover, as selection of the appropriate plant species is an important efficiency parameter and mediterranean halophytes are proven to be ideal candidates.

Results obtained in MADFORWATER

With influent municipal wastewater heavy metals concentrations up to twice the limits for WW reuse for irrigation, CWs means removal capacities up to 99% for Cd, 51% for Ni and 45% Zn are noted. With influent concentrations of emerging organic contaminants 100µg/L of bisphenol A (BPA), 1mg/L of ciprofloxacin (CIP) and 5 mg/L of sulfamethoxazole (SXS), CWs means removal efficiency up to 76% for BPA, 94% for CIP and 27% for SXS are recorded. These

results have been obtained without the effect of plant growth promoting bacteria on the overall efficiency of the process.

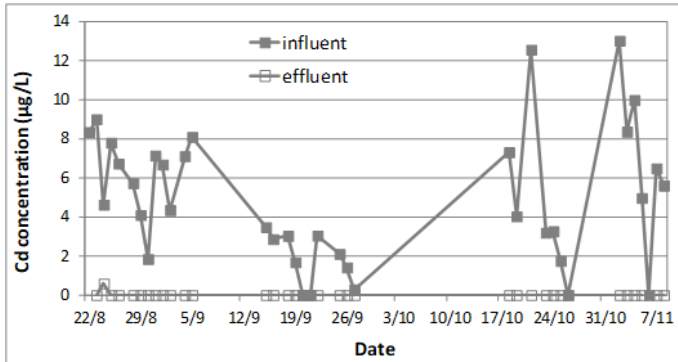

Cd concentration in the constructed wetland influent and effluent

Specific obstacles relative to the application of this technology in Egypt, Tunisia and/or Morocco and to the production of irrigation-quality treated wastewater according to the ISO 16075 standard (max 5 lines)

None.

Constructed wetlands

Specific pollutants targeted by

Pharmaceuticals, organic micro-pollutants

Technology description

This technology utilizes laccases immobilized onto resin particles with a low pressure drop in a packed bed reactor fed with a continuous flow of wastewater. Laccases have been selected since they can catalyze the oxidation of a wide range of phenolic and nonphenolic lignin-related compounds, including many pharmaceuticals and micropollutants commonly occurring in municipal WW and typically not degraded in conventional municipal WWTP, they can be relatively simply isolated and purified from white rot fungi. Besides allowing continuous operation, immobilization on solid supports has been demonstrated to enhance enzyme stability.



Packed bed column with immobilized enzymes

Specific features that make this technology suitable for the context of Egypt, Tunisia and/or Morocco and for the attainment of the ISO 16075 standard for agricultural WW reuse

The packed bed reactor is easy to operate, does not require sophisticated instrumentation, regulation or high pressure pumps and it could be more suitable compared to other reactor configurations, such as membrane reactors, for wastewater treatment in African countries.

Results obtained in MADFORWATER

Laccases from *P. sanguineus* (L1) and *T. versicolor* (L2) were immobilized onto resin particles or fumed silica nanoparticles (fsNP) and tested in a batch reactor on spiked municipal wastewater (500ng/L of each compound). The most efficient laccase (from *P. sanguineus*) removed 7-83% of the pharmaceuticals after 5 days. Treatment of the real municipal wastewater was performed with the laccase from *P. sanguineus* in a packed bed reactor with a continuous flow rate. Adsorption of the micropollutants onto the enzyme

carriers was observed in preliminary tests, hampering quantification of the pollutants degradation.

Concentrations of pharmaceuticals in real municipal wastewater samples from Tunisia and Morocco

ng/L	Tunisia	<u>Dragra</u>	<u>Tiznit</u>
4-Acetamidoantipyrin	n.d.	163	112
<u>Amisulpride</u>	78	n.d.	101
Atenolol	384	117	219
Atenolol Acid	151	124	90
Carbamazepine	237	245	443
Carbendazim	50	99	162
<u>Celiprolol</u>	180	n.d.	19
Climbazole	279	719	583
Fluconazole	164	512	407
Irbesartan	461	101	46
<u>Niflumic Acid</u>	383	389	218
<u>Sulpiride</u>	161	70	178

Specific obstacles relative to the application of this technology in Egypt, Tunisia and/or Morocco and to the production of irrigation-quality treated wastewater according to the ISO 16075 standard

This technology is considered as tertiary treatment. Primary treatment and secondary biological treatment should be integrated. Costs of enzymes and resin used for immobilization are relatively high.

2 - An innovative approach for the treatment and valorization of olive mill wastewater

Main pollutants to be removed for an agricultural reuse

Organic compounds (COD 20-100 g/L); polyphenols (1-10 g/L)

Technologies mainly used in Egypt, Morocco and Tunisia for the treatment of this wastewater: (max 8 lines)

According to Tunisian legislation, the main practice to manage olive mill wastewater (OMWW) is to discharge it into evaporation ponds. This treatment process aims to reduce the impact of OMWW on the environ-

environment, with the unfortunate side effect of severe odor emission. This is caused by the flotation of residual oily substances in the OMWW, inhibiting evaporation and creating anaerobic conditions. Odors are the main disadvantage of evaporation ponds, especially for those operating near domestic areas.

Short presentation of the technologies developed by MADFORWATER for this wastewater:

MADFORWATER is developing two alternative treatment trains for OMWW: the first one is articulated in suspended solids removal by microfiltration, polyphenol recovery from the filtrate by adsorption and final BOD removal by biomethanation; the second one consists in an aerobic biological treatment in a sequenced batch reactor with lime addition. These technologies are briefly presented in the following tables.

MICROFILTRATION AND POLYPHENOL RECOVERY BY ADSORPTION

Specific pollutants targeted by this technology:

Suspended solids and polyphenols

Technology description

An initial microfiltration step, aimed at the removal of suspended solids, is followed by an adsorption / desorption step aimed at the recovery of polyphenols.

This leads to the production of i) a polyphenol-rich mixture that, thanks to its high antioxidant capacity, can find application in several industrial processes or products formulation and ii) a dephenolized water that can be treated biologically more efficiently.

Two columns operate in parallel: while the first one adsorbs polyphenol from olive mill wastewater, the second desorbs the antioxidants collected during the previous cycle. The desorption solvent (typically ethanol) is entirely recycled within the process by evaporation and re-condensation.

Pilot plants for the microfiltration and adsorption of olive mill wastewater



Specific features that make this technology suitable for the context of Egypt, Tunisia and/or Morocco and for the attainment of the ISO 16075 standard for agricultural WW reuse

This technology is suitable for the North African context thanks to its capacity to produce an antioxidant mixture that can potentially have a relevant market value. At the same time, the removal of polyphenols from olive mill wastewater is important in order to avoid any potential crop damage associated to the antioxidant and antimicrobial activity of these compounds.

Results obtained in MADFORWATER relatively to this technology

The removal of suspended solids by filtration was very high (98%) and characterized by a limited, acceptable loss in polyphenols (9%) with the solids. Different types of resins were tested for the polyphenol recovery step from the water phase. A neutral adsorption resin (XAD 16) was selected as the most effective one. It leads to the recovery of a polyphenol mixture characterized by a very high antioxidant capacity. Polyphenol removal is equal to about 90%, leading to a residual polyphenol concentration in the treated effluent equal to about 0.1 g/L.

Polyphenol outlet concentration versus time in the outlet of an adsorption test. Experimental data and best-fitting simulation

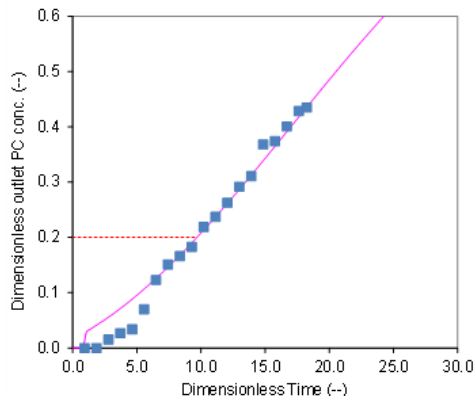

Specific obstacles relative to the application of this technology in Egypt, Tunisia and/or Morocco and to the production of irrigation-quality treated wastewater according to the ISO 16075 standard (max 5 lines)

- In order to produce an irrigation-quality water, the proposed technology must be integrated by a treatment step aimed at the biodegradation of organic compounds (e.g., anaerobic digestion).
- The operation of the proposed technology requires personnel with adequate technical skills, capable to manage adsorption, evaporation and condensation processes.
- Some safety issues are related to the need to stock ethanol. Local legislation on safety in workplaces must be carefully applied.

ANAEROBIC DIGESTION

Specific pollutants targeted by this technology:

Organic matter

Technology description

Biodegradable organic compounds (BOD) are converted into methane and carbon dioxide thanks to the combined action of acidogenic and methanogenic microorganisms. The process is operated under anaerobic conditions at 35-40 °C in a stirred reactor. Dephenolized olive mill wastewater can be co-digested in combination with other agricultural wastes. The produced biogas is typically burned, leading to a combined production of heat and electrical energy.

Anaerobic digestion pilot plant

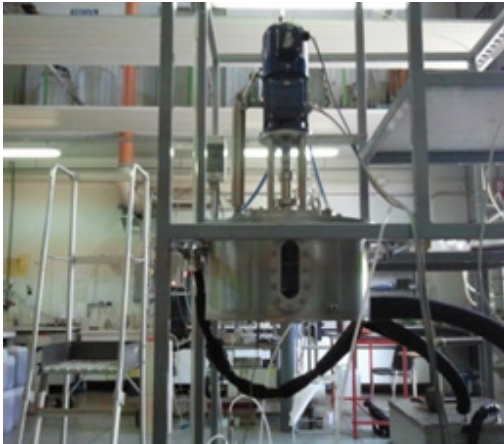

Specific features that make this technology suitable for the context of Egypt, Tunisia and/or Morocco and for the attainment of the ISO 16075 standard for agricultural WW reuse

Anaerobic digestion is characterized by a medium-low level of technical complexity and by a null energy consumption. On the other hand, it leads to the production of electrical energy that can be sold to the local energy grid. The production of irrigation-quality water requires a high retention time for the complete removal of BOD, and a further treatment step for solid / liquid separation (for example, a filter-press). The solid digestate produced can be used as a fertilizer.

Results obtained in MADFORWATER

The results indicate that olive mill wastewater is a good candidate for the anaerobic digestion process, with a relatively high yield of methane production (260-400 NLCH₄/kgvolatile solids) and an acceptable methane production rate (110-200 LCH₄/m³digestate/d). Previous olive mill wastewater dephenolization leads to a 30-40% increase of the process performances. The tests aimed at evaluating the capacity of the process to attain the low BOD concentrations

centrations required by the ISO standards for water reuse in agriculture (< 100 mg/L) are still in progress.

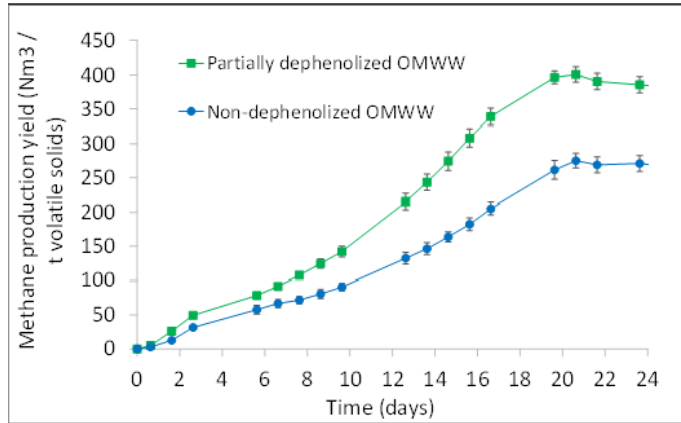

Methane production yield obtained with dephenolized and non-dephenolized OMWW

Specific pollutants targeted by this technology:

Anaerobic digestion of olive mille wastewater is considered suitable for the specific context of Egypt, Morocco and Tunisia.

AEROBIC BIOLOGICAL TREATMENT IN A SEQUENCED BATCH REACTOR

Specific pollutants targeted by

Organic compounds, Phenolics

Technology description (max 8 lines + 1 picture + 1 flow sheet)

Sequenced Batch Reactors (SBR) are a special form of activated sludge treatment in which the whole treatment process takes place in the reactor tank and clarifiers are not required. This process treats the wastewater in batch mode and each batch is sequenced through a series of 5 treatment stages: 1. Fill; 2. React; 3. Settle; 4. Decant and 5. Idle.

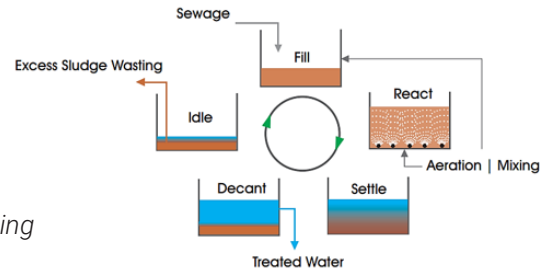

SBR operating principle

First, the tank is filled by the OMWW. During the second stage, mixing is provided by mechanical means and aeration of the mixed liquor is performed via diffusers fixed to the floor of the tank. No aeration and mixing are provided in the third stage to settle the suspended solids. During the fourth stage the OMWW treated supernatant is recovered. In the fifth stage the excess sludge is removed.

The treated wastewater is then subject to lime addition under pulverulent form (CaO) until pH 12.

Specific features that make this technology suitable for the context of Egypt, Tunisia and/or Morocco and for the attainment of the ISO 16075 standard for agricultural WW reuse

Sequencing batch reactor (SBR) could be applied for nutrients removal, high biochemical oxygen demand containing industrial wastewater, wastewater containing toxic materials such as cyanide, copper, chromium, lead and nickel, food industries effluents, landfill leachates and tannery wastewater. Of the process advantages are single-tank configuration, small footprint, easily expandable, simple operation and low ca-

pital costs. Moreover, it allowed the establishment of a stable microbial population, capable of degrading potentially toxic compounds. The addition of pulverulent lime permits further removal of COD and phenolics by both coagulation and adsorption phenomena.

Results obtained in MADFORWATER

The SBR reactor was seeded with a sample of activated sludge from a municipal wastewater treatment plant, which was stepwise acclimatized towards the high COD content present in the OMWW by operating the reactor for several sequenced batches with a hydraulic retention time of 30 days each and increasing COD concentrations in the influent OMWW up to 75 g L⁻¹. Similar COD reduction efficiencies (about 60%) have been achieved after each sequenced batch with a stable removal rate of 1.5 gCOD L⁻¹ D⁻¹, indicating the presence of a stable microbial consortium. The combination of biological treatment to pulverulent lime addition allowed the removal of up to 80% and 90% of COD and phenolics respectively. However, the COD of the treated OMWW still exceeds the standards for irrigation water indicated in ISO and Tunisian standards (NT 106.03).

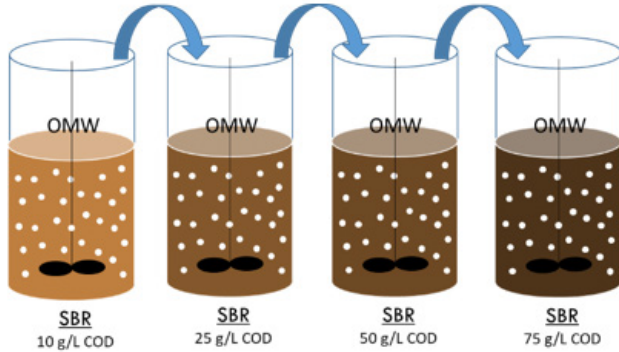

Stepwise acclimatization of the aerobic consortium to high OMWW concentrations in a SBR

Specific obstacles relative to the application of this technology in Egypt, Tunisia and/or Morocco and to the production of irrigation-quality treated wastewater according to the ISO 16075 standard

This technology is suitable for the specific context of Egypt, Morocco and Tunisia. No specific obstacles are reported in relation to the production of irrigation-quality treated wastewater. However, additional dilution or treatment is required in order to further reduce the remaining COD concentration.

3 - Innovative treatment trains for the treatment of textile wastewater

Main pollutants to be removed for an agricultural reuse:

Azo dyes, sulfonated azo dyes

Technologies mainly used in Egypt, Morocco and Tunisia for the treatment of this wastewater

The current situation of textile wastewater (TWW) treatment in these three countries is quite diverse. Some textile companies have already integrated internal wastewater treatment processes into their process sequences, aiming to reach up to 60% reintegration of the sewage into the processes. The remaining treated wastewater is discharged into the municipal sewage network. Coagulation is a widely applied process as a pre-treatment prior to principal treatment by activated sludge, oxidation or membranes. Coagulation aims to remove colloidal particulates and organic substances. The efficiency of the current processes is generally instable in relation to the important daily and seasonal variation of effluents volume and of

organic and mineral load. An adequate process able to tolerate occasional peaks of effluent volume and organic load must be used. In some cases, textile effluents are discharged directly into the municipal sewage network without any pre-treatment.

Short presentation of the technologies developed by MADFORWATER for this wastewater

MADFORWATER is developing a secondary treatment process in moving bed biological reactor (MBBR) to be applied downstream a coagulation/flocculation step, in order to degrade COD and azodyes, and two alternative tertiary treatment processes aimed at removing the residual dyes, namely i) dyes enzymatic degradation in packed bed reactors with immobilized laccases and, ii) dyes adsorption/desorption with innovative magnetic resins.

These technologies are briefly presented in the

Moving Bed Biological Reactor

Specific pollutants targeted by this

Toxic azodyes

Specific pollutants targeted by this technology:

The wastewater contaminated with toxic dyes is pumped into the first mixing tank with a peristaltic pump where coagulants - flocculants are added and then it overflows to the primary clarifier for precipitation of suspended particles. The supernatant wastewater from this tank flows to the tank with carriers (MBBR), where biological degradation occurs. An aerator provides oxygen to the water and fluidize biofilm carriers. The sludge is allowed to settle in the secondary clarifier tank which follows, while the effluent from this tank is recirculated through a peristaltic pump to the biodegradation tank (MBBR). The system was operated as a batch reactor, since only the MBBR reactor and the secondary clarifier tank were operated by recirculation.

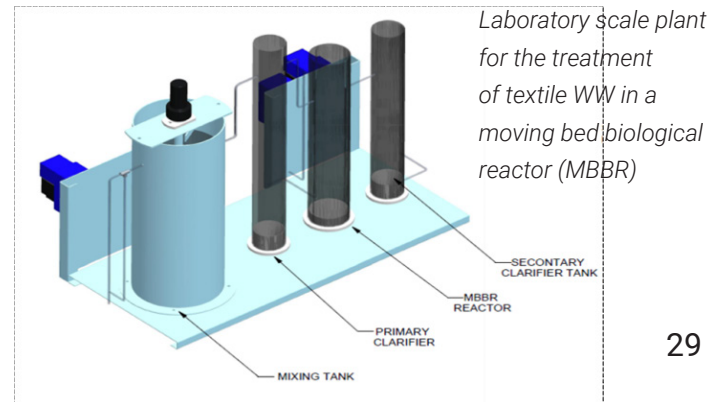

Specific features that make this technology suitable for a MAC context and for the attainment of the international standards for agricultural WW reuse

This technology has proven effective in the biodegradation of dyes whose presence in textile wastewaters has been identified as a critical issue for their reuse in irrigation.

Results obtained in MADFORWATER

MBBR was fed with synthetic wastewater supplemented with 0.08 to 0.48 g L⁻¹ dye concentrations. These concentrations are typically obtained after primary treatment with coagulants. An efficient consortium isolated from marine environment was inoculated to the system, developing the biomass on freely moving carriers. The decolorization efficiency of the system was above 80% for all tested dyes after 95 days operational period. Ammonium nitrogen, total nitrogen and total phosphorous were measured 1.2, 35 and 2.7 mg/l respectively. According to the maximum levels of nutrients in TWW used for irrigation (ISO 16075-1-2015) which are 30 for ammonium nitrogen, 35 for total nitrogen and 7mg/l for total phosphorous the treated TWW can be used for

irrigation (ISO 16075-1-2015) which are 30 for ammonium nitrogen, 35 for total nitrogen and 7mg/l for total phosphorous the treated TWW can be used for irrigation.

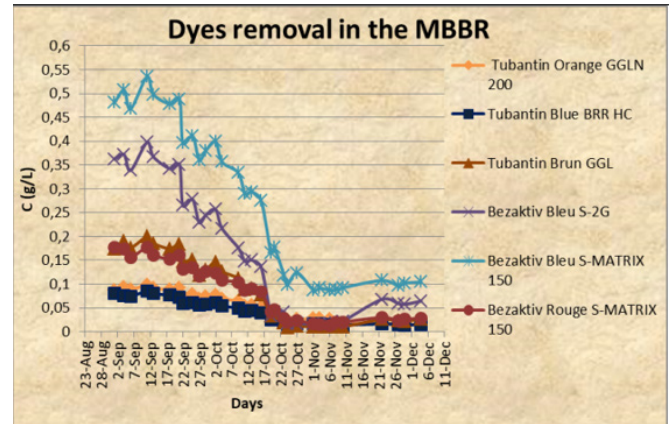

Dyes removal from textile WW in the moving bed biological reactor (MBBR)

Specific obstacles relative to the application of this technology in a MAC context and to the production of irrigation-quality treated WW

Overall, there should be no problem in the application of the MBBR technology; however, care should be

no problem in the application of the MBBR technology; however, care should be taken of the sludge removal from the primary step. If the quantities are small (when expensive coagulants are used) simple drying and disposal should be OK. In the case where lime is used, the amount of watery sludge being produced is very high (almost 30 to 50% of the initial wastewater volume) and a specific treatment technology for this must be considered.

Moving Bed Biological Reactor

Specific pollutants targeted by this technology:

Azo dyes, sulfonated azo dyes

Specific pollutants targeted by this technology:

Laccases and peroxidases are known enzymes with ability to decolorize various types of dyes. This technology is utilizing immobilized enzymes in packed bed reactor to treat textile wastewater. Immobilization of the enzymes usually improves enzyme stability. Resin particles (100-300 μ m size) were used as enzyme carriers and the packed bed reactor is operated at continuous flow rate.



Lab-scale bioreactor for dye removal with immobilized enzymes

Specific features that make this technology suitable for the context of Egypt, Tunisia and/or Morocco and for the attainment of the ISO 16075 standard for agricultural WW reuse

The packed bed reactor is easy to operate, does not require sophisticated instrumentation, regulation or high pressure pumps and it could be more suitable compared to other reactor types using immobilized enzymes, such as membrane reactors, for wastewater treatment in African countries.

Results obtained in MADFORWATER

Six sulfonated azo dyes have been selected as the

the main contaminants of the real textile wastewater. Laccases from the fungi *P. sanguineus* and *T. versicolor* were able to decolorize two out of six dyes. Dye-decolorizing peroxidase did not remove any of the dyes and horseradish peroxidase degraded only one dye. Redox mediators enable laccase to oxidize more compounds. The oxidation step is performed by the oxidised form of the mediator, generated on its interaction with laccase. Three different redox mediators have been tested and 1mM 1-hydroxybenzotriazole showed the highest extent of decolorization. Partial decolorization was observed in the real textile wastewater that was spiked by six dyes and treated by laccase from *T. versicolor*. In experiments performed with immobilized laccases, dyes adsorption of the enzyme carrier mainly occurred, with negligible dyes degradation.

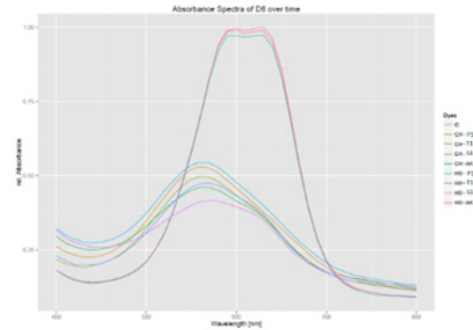

Decolourization of dyes Bezaktiv Bleu S-Matrix 150 and Bezaktiv Bleu S-2G by laccases, as indicated by the reduction of absorbance at 600 nm.

Specific obstacles relative to the application of this technology in Egypt, Tunisia and/or Morocco and to the production of irrigation-quality treated wastewater according to the ISO 16075 standard

This technology is highly dependent on quality of the textile wastewater. Enzymes are not able to decolorize a big range of structurally different dyes and if the composition of the wastewater significantly fluctuate this technology may become inefficient. Negatively charged dyes are adsorbed by the enzyme carriers. Costs of enzymes and resin used for immobilization

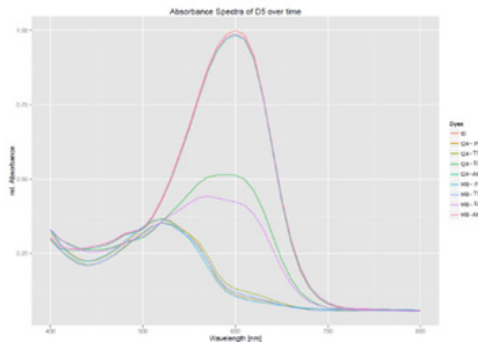

are relatively high.

Adsorption on innovative resins

Specific pollutants targeted by this technology:

Dyes and dissolved organic matter

Specific pollutants targeted by this technology:

The magnetic anion exchange resin (MAER) developed by Nanjing University, China is designed specifically to remove organic matter and negative-charged dyes from water and wastewater. The MAER has a polyacrylic matrix, a macroporous structure and strong-base functional groups. The resin beads have a diameter of 100-200 μm , which has high surface area and mass transfer rate than the conventional resins. The MAER is used in suspended manner in a completed mixed flow reactor. The magnetic core aids agglomeration and settling of the resin. The MAER can be regenerated by 10% NaCl solution and the reactor utilize a side-stream, continuous regeneration process allowing for a consistent treated water quality. About 200~300 m^3 wastewater generates 1 m^3 brine wastewater.

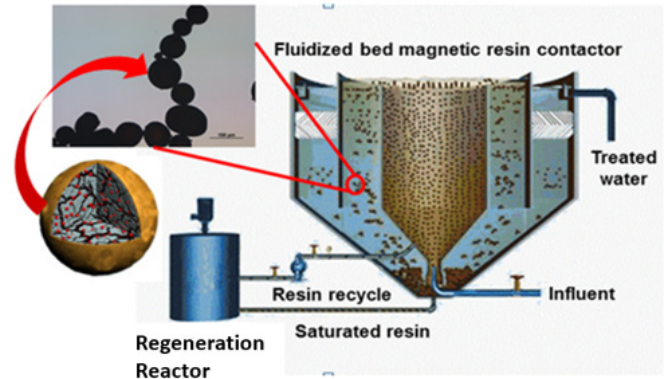

The magnetic anion exchange resin and the fluidized-bed reactor

Specific features that make this technology suitable for the context of Egypt, Tunisia and/or Morocco and for the attainment of the ISO 16075 standard for agricultural WW reuse

The MAER has fast and good treatment capacity for removal of most negative-charged organic matter and dyes. However, the usage of NaCl and the treatment of the brine wastewater from resin regeneration process limits its large application. The textile factory in these countries usually generates $\sim 200 \text{ m}^3$ wastewater per day, which means $\sim 1 \text{ m}^3$ brine wastewater

stewater is produced every day. The price of NaCl is cheap and the brine wastewater can be easily evaporated according to local drought climate.

Results obtained in MADFORWATER

A novel permanent-magnetic anion exchange resin MAER was developed by use of diallyl itaconate (DAI) as the crosslinker, which significantly improved the hydrophilicity, strength and adsorption capacity. The dye-saturated MAERs can be efficiently regenerated by a mixture of NaCl/NaOH solution (10%/1%). During 20 cycles, the MAER could be reused without a noticeable decline in adsorption capacity for the dye Orange-G, indicating a superior anti-fouling performance for removal of organic matter. Taken together, the high capacity, fast kinetics, excellent reusability and convenient separability of MAER made it a good candidate for organic matter removal.

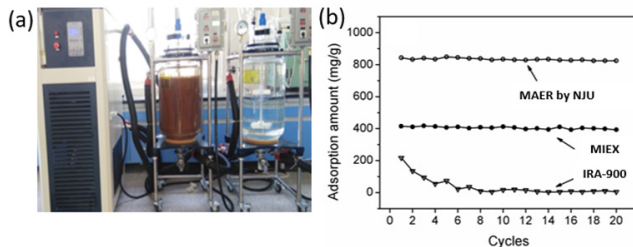

The synthesis for the permanent-magnetic anion exchange resin (MAER) and its adsorption capacity to the dye Orange-G in comparison with the commercial MIEX and IRA-900 anion exchange resin

Specific obstacles relative to the application of this technology in Egypt, Tunisia and/or Morocco and to the production of irrigation-quality treated wastewater according to the ISO 16075 standard

The anion exchange resins cannot remove those fibers, organic matter or dyes which are not negatively-charged in textile wastewater. This technology must comply with the other wastewater treatment technologies.

4 - An innovative approach for the treatment of fruit and vegetable packaging wastewater

Main pollutants to be removed for an agricultural reuse:

Organics (COD), suspended solids, fungicides

Technologies mainly used in Egypt, Morocco and Tunisia for the treatment of this wastewater: (max 8 lines)

Depending on local conditions, different treatment options are currently used for wastewaters from fruit and vegetable packaging, such as septic tanks, aerobic lagoons or activated sludge. These treatment technologies are capable of removing part of the critical contaminants (persistent organics, suspended solids and fungicides), but the resulting effluent quality is low with respect to the reuse standards.

Short presentation of the technologies developed by MADFORWATER for this wastewater: (5 lines)

To achieve high quality effluent which can meet reuse standards, a treatment train combining different technologies was designed: Moving bed biofilm reactor (MBBR) to remove organic contaminants and fungicides, Integrated flotation and flocculation to efficiently remove suspended solids and UV-Oxidation/Immobilised enzymes to remove residual fungicides. As an alternative to the last technology, sorption on activated carbon can be applied for the fungicide removal.

Aerobic moving bed bioreactor

Specific pollutants targeted by this technology:

Dissolved and colloidal organic contaminants

Technology description

The technology is based on the use of small plastic carrier elements with density similar to water, which are colonized by microorganisms in the form of a biofilm. The carriers are mixed with wastewater in an aerated tank and the microorganisms remove degradable organic matter from the wastewater. Aeration of the bioreactor serves for mixing and supply of oxygen to the microorganisms. The needed contact time for the specific wastewater is between 1 and 4 days, depending on the initial concentration of the fungicides. Subsequently, the treated wastewater is removed from the bioreactor, whereas the carriers are retained inside by a sieve. The biological processes generate certain amount of excess biomass, which is separated in the subsequent flocculation and dissolved air flotation (DAF) step, together with the suspended solids originating from the wastewater.

MBBR carriers with developed biofilm



Specific features that make this technology suitable for the context of Egypt, Tunisia and/or Morocco and for the attainment of the ISO 16075 standard for agricultural WW reuse

The presence of toxic and poorly degradable compounds in the specific wastewater can negatively affect the microorganisms during the biological treatment. The biomass attached to the carriers is less sensitive to these compounds and can be reliably retained in the reactor, preventing the wash-out of slow growing organisms. The MBBRs also allow high biomass density and thus the use of compact reactors. The technology is simple to implement and operate.

Results obtained in MADFORWATER

Various wastewater streams originating from the fruit and vegetable processing, as well as their mixtures, were treated by the MBBR technology. The MBBR technology itself could remove 65 to 80 % of the organic contamination (COD). After acclimation, the biological treatment can remove over 90% of the fungicides. Some fungicides were efficiently removed as well, but others remained in the wastewater in the treated water. In case the removal of fungicides in

the biological reactor is insufficient, post-treatment by adsorption can be installed as additional step. The treated wastewater also contained suspended solids. These contaminants are addressed by the second step of the treatment technology: integrated flocculation and flotation, which is an integral part of the proposed treatment train.

Removal of COD, turbidity and thiabendazole (fungicide) from the wastewater by MBBR technology at different hydraulic retention time

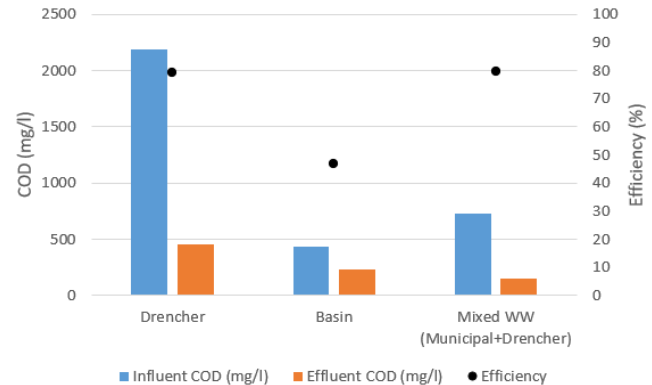

Specific obstacles relative to the application of this technology in Egypt, Tunisia and/or Morocco and to the production of irrigation-quality treated wastewater according to the ISO 16075 standard

The production of the wastewater from fruit and vegetable packaging/processing is seasonal. However, the MBBR – like other biological wastewater treatment methods – relies on continuous supply of substrate. Alternative wastewater (e.g. a municipal stream) is necessary for the downtime periods.

Aerobic moving bed bioreactor (MBBR)

Specific pollutants targeted by this technology:

Suspended solids, colloids

Technology description

The principle of dissolved air flotation (DAF) is the removal of suspended particles from wastewater by using micro-bubbles which are generated once pressurized and air-saturated water is released to ambient pressure. The bubbles attach to the particles and carry them to the surface, where they form a sludge blanket (up to 3 - 6%

dry solids). The particles in the wastewater need to be coagulated and flocculated before the introduction of air-saturated water to facilitate the agglomeration between the particles and micro-bubbles. In the proposed scheme DAF is coupled to MBBR treatment to remove particles and excess biomass. Optionally powdered activated carbon can be dosed to the influent to the DAF for the sorption of residual fungicides.

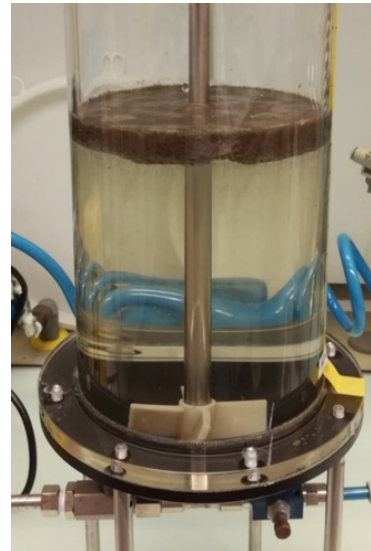

Separation of suspended solid in a lab scale flotation unit

Specific features that make this technology suitable for the context of Egypt, Tunisia and/or Morocco and for the attainment of the ISO 16075 standard for agricultural WW reuse

Compared to sedimentation the energy consumption of DAF is higher, on the other hand it can provide very efficient solids removal at very short hydraulic retention time (few minutes). This enables to construct a compact unit with high volumetric throughput. Highly efficient removal of contaminated solids from the fruit packaging wastewater provides highly purified water suitable for reuse.

Results obtained in MADFORWATER

The combined DAF process was proposed for the removal of suspended solids after the biological treatment by MBBR. It could efficiently remove suspended solids from the wastewater samples originating in the fruit and vegetable packaging plant to <5 mg/l. Together with the MBBR unit the COD removal efficiency was up to 95%, depending on wastewater composition. The best water quality was COD < 30 mg/l and BOD < 5 mg/l. The combined process could also remove fungicides to < 0.1 mg/l, except for thiabendazol, which was present in highest con-

centration. Dosing of powdered activated carbon to the influent of the flotation could provide additional removal of the fungicide (approx. 90%).

Specific obstacles relative to the application of this technology in Egypt, Tunisia and/or Morocco and to the production of irrigation-quality treated wastewater according to the ISO 16075 standard

No specific obstacles are reported.

UV-oxidation with TiO₂-coated beds combined to immobilized enzyme bioreactors

Specific pollutants targeted by this technology:

Thiabendazole

Technology description

The post treatment is performed in a photoreactor with immobilized titanium dioxide. The reactor is operating continuously at sunlight. The main photo-transformation products are hydroxy derivatives of fungicides which represent more amenable sub-

strates for biocatalytic degradation. The following treatment technology is utilizing immobilized laccases. Resin particles with a low pressure drop were selected as enzyme carriers thus a continuous packed bed reactor can be constructed and operated.

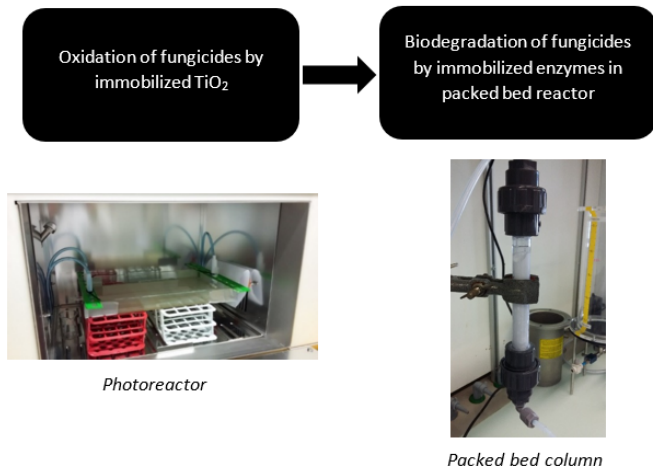

Packed bed reactor for the enzymatic treatment of fruit packaging wastewater

Specific features that make this technology suitable for the context of Egypt, Tunisia and/or Morocco and for the attainment of the ISO 16075 standard for agricultural WW reuse

The photoreactor does not require UV lamps or energy for oxidation. It can be operated at sunlight. The packed bed reactor is easy to operate, does not require sophisticated instrumentation, regulation or high pressure pumps and it could thus be more suitable than other bioreactor configurations, such as membrane bioreactors, for wastewater treatment in African countries.

Results obtained in MADFORWATER

Thiabendazole in synthetic wastewater could be degraded by immobilized titanium dioxide up to 94% in 120 min. Analysis of titanium dioxide particles in treated effluent showed a very low release (<1%) which confirmed a good mechanical stability of the immobilized photocatalyst. However, efficiency of the photo-reactor was significantly influenced by wastewater matrix and decreased by biofouling, since photodegradation of thiabendazole in real wastewater was not observed. Washing steps of the photoreactor should be incorporated in the treatment process.

Degradation of thiabendazole by immobilized laccase was not observed.

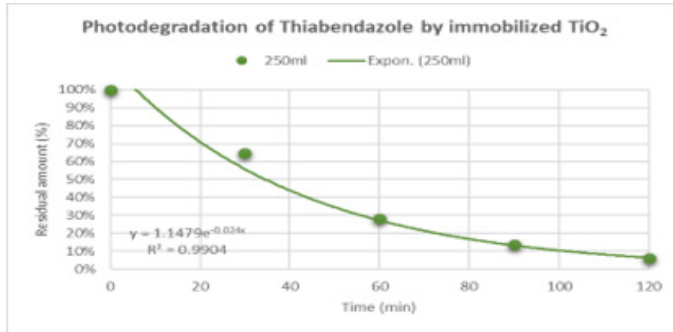

Photodegradation of thiabendazole by immobilized laccase

Specific obstacles relative to the application of this technology in Egypt, Tunisia and/or Morocco and to the production of irrigation-quality treated wastewater according to the ISO 16075 standard

The photoreactor can operate only during the day because a sunlight is required. Additional UV lamps has to be installed if operated at night. Costs of enzymes and resin used for immobilization are relatively high.

5 - A sustainable approach for the treatment and valorization

Main pollutants to be removed for an agricultural reuse:

Organic compounds (COD 200-600 mg/L); ammonia (2-10 mg/L) and nitrate (2-10 mg/L)

Technologies mainly used in Egypt for the treatment of this wastewater:

No treatment is actually performed on drainage canal water before it is used for irrigation.

Short presentation of the technologies developed by MADFORWATER for this wastewater:

MADFORWATER is developing the use of canalized facultative lagoons in order to remove BOD and N (nitrification/denitrification) from drainage water of the Nile delta region. The aim is to propose the conversion of the existing drainage canals receiving drainage water and local wastewaters into canalized facultative lagoons through proper design.

FACULTATIVE CANALISED LAGOON

Specific pollutants targeted by this technology:

Organic compounds, ammonia and nitrate.

Technology description

The technology consists in canals, where contaminated water flows by gravity, properly designed in terms of geometry (e.g., depth) and fluid dynamics (e.g., through baffles) in order to attain the establishment of i) an upper sun-irradiated aerobic layer, where microalgal growth contributes to water oxygenation, ii) a dark aerobic layer, where only growth of aerobic, COD-removing heterotrophic bacteria and of chemolithotrophic ammonium-oxidizing bacteria takes place, iii) a lower anoxic/anaerobic layer, where facultative bacteria reduce nitrate further contributing to COD removal, and iv) the suitable oxygen and mass transfer rates between layers.

Technology description

The technology consists in canals, where contaminated water flows by gravity, properly designed in terms of geometry (e.g., depth) and fluid dynamics (e.g., through baffles) in order to attain the establishment of i) an upper

sun-irradiated aerobic layer, where microalgal growth contributes to water oxygenation, ii) a dark aerobic layer, where only growth of aerobic, COD-removing heterotrophic bacteria and of chemolithotrophic ammonium-oxidizing bacteria takes place, iii) a lower anoxic/anaerobic layer, where facultative bacteria reduce nitrate further contributing to COD removal, and iv) the suitable oxygen and mass transfer rates between layers.

Specific features that make this technology suitable for the context of Egypt and for the attainment of the ISO 16075 standard for agricultural WW reuse

This technology is suitable for the North African context thanks to the warm climate that allows an effective removal of pathogens and coliforms. Because of the simplicity in construction and low power and maintenance costs, especially with systems designed to operate with gravity flow, facultative lagoons are also desirable in developing countries. Drainage canals are already existing in the Nile delta area: a conversion of the existing canals into facultative canalized lagoons would not impact significantly on the surface of land covered (a typical disadvantage

of conventional facultative lagoon ponds).

Results obtained in MADFORWATER relatively to this technology

A laboratory reactors system consisting in three hydraulically connected bioreactors (V1, V2, V3, see figure) was set up to simulate the layers of facultative canalized lagoons, i.e., the COD removal, nitrification and denitrification processes taking place, and the mass transfer phenomena among them. The dark portion of the system (V1 reactor disconnected and replaced by air purging in V2 reactor) was tested preliminarily on a synthetic WW inoculated with a bacterial community previously enriched from a drainage canal of the Nile delta area. Removal of initial COD (450 mg L^{-1}) up to 90 mg L^{-1} (overall average removal rate of $65 \pm 4 \text{ mg L}^{-1} \text{ h}^{-1}$), as well as a $\text{NH}_4\text{-N}$ removal rate of $2.4 \pm 0.3 \text{ mg L}^{-1} \text{ h}^{-1}$ and $\text{NO}_3\text{-N}$ removal rate of $25 \pm 2 \text{ mg L}^{-1} \text{ h}^{-1}$ were observed when the 2 reactors (V2 = 2L, V3 = 1L) were hydraulically connected with a flow rate of 2.08 mL min^{-1} . Connection of the aerobic photo reactor (V1) and optimization of the layers volume ratio and flow rate, will provide the information on the canal depth and turbulence required to convert it in a facultative lagoon system able to

lagoon system able to attain the water quality standards for irrigation.

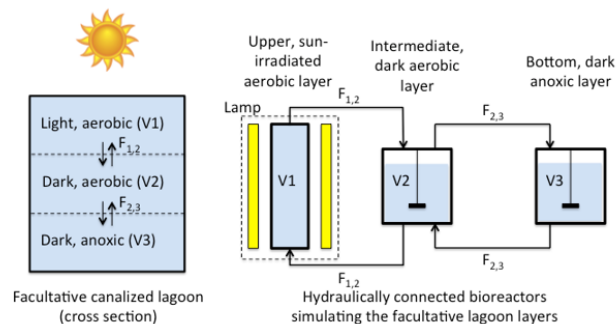

Schematic representation of the facultative canalized lagoon layers and of the laboratory plant set up for the simulation of facultative canalized lagoons.

Specific obstacles relative to the application of this technology in Egypt and to the production of irrigation-quality treated wastewater according to the ISO 16075 standard

- Optimization may require the modification of the geometry (depth) and fluid dynamics (insertion of baffles) of specific canal portions
- Limited control on the operating parameters (e.g.,

turbulence through modification of baffles distance and depth); seasonal changes of weather conditions (temperature, light intensity, daylight duration) might partially affect the process performances.

7. Irrigation technologies developed by the MADFORWATER project

1 - An efficient low-pressure anti-drift micro sprinkler adapted to treated wastewater

Type of crops “targeted” by this technology

This innovative mini-sprinkler is designed in particular for orchard trees with under canopy irrigation.

Benchmark technology used in Egypt, Morocco and Tunisia for the irrigation of these crops

In the targeted countries the orchards are typically irrigated by drippers, when the water is of good quality, or micro-sprinklers when clogging problems are more frequent due to the suspended solids carried by the irrigation water.

Technology description

This technology can be used to irrigate orchard trees under canopy in a configuration that prevents water contact with the consumable parts of the plant. The objective is to develop a low-cost mini-sprinkler, that minimizes pathogen risk dissemination due to aerosols issued from the smaller droplets and that resists to the potential clogging related to the use of treated wastewater. This micro-sprinkler, designed to manage the size of droplets produced to minimize the generation of small droplets, is intended to work at low operating pressure (< 2 bar). The droplet diameter varies between 0.5 mm and 2.5mm for more than 95% of the delivered volume: higher than 0.5 mm to avoid droplet drift because of wind and lower than 2.5 mm to avoid soil sealing due to droplet impaction. The control of the particle size distribution is achieved through the combination of nozzle size, operating pressure, deflector’s canal shape and rotation velocity. Designing prototypes and optimizing the shape of this innovative sprinkler is an important part of this research. In terms of maintenance and water conditioning the objective to achieve is a long term operation with a coarse filtration of 0.500 mm.

In terms of cost, this technology is a non-complex plastic device, easy to build and costless. Its operating pressure is low thus its setting up will combine noncomplex infrastructure and easiness to use. In terms of environmental impact, the low operating pressure allows to reduce losses of water and to avoid large pumping (high energy demanding) stations.



Anti-drift micro-sprinkler

Features that make this technology suitable for the context of Egypt, Tunisia and/or Morocco and for the use with treated WW

The targeted countries have in common a marked

water scarcity and a high evaporative climate. The purpose of this technology is first to have the capability to reuse treated wastewater with minimum clogging risk, then to minimize the risk of pathogen dissemination under windy conditions by attaining a droplet size that restricts the potential drift. This, in turn, will decrease the potential evaporation.

Results obtained in MADFORWATER relatively to this technology

The results obtained to date are mainly droplet size distribution along the radius. These data were obtained using a laser-optical disdrometer that counts droplets and estimates their sizes. Measurements show that droplet size range are close to the intended range of diameter. We performed experiments with aquaculture effluents to test this technology with a wastewater characterized by a relevant presence of suspended solids (> 200 mg/L) that didn't change the range of droplet size distribution. The analysis of wind impact on water distribution and particle size distribution is in progress.

Specific obstacles relative to the application of this technology with treated WW, in Egypt, Tunisia and/ or Morocco

Obstacles to the design of such a micro-sprinkler with high durability and anti-drift properties are related to the selection of materials that prevent biofilm development, and proper shape of the deflector to adapt distribution characteristics through rotation velocity and resist to fatigue. The identification of plasticized materials was obtained from a dedicated experiment with real TWW.

2 - An irrigation emitter resistant to clogging

Type of crops “targeted” by this technology

This type of emitter can be used on permanent as well as temporary high value crops, but it is not suitable for cereals and other more extensive crops.

Benchmark technology used in Egypt, Morocco and Tunisia for the irrigation of these crops

This type of emitter is an alternative solution to drip irrigation emitters,

as it doesn't require a filtration finer than 1 mm size after decantation of the effluent. This property is obtained by a high discharge, preventing any deposit in the emitter that may lead to clogging and decrease the distribution uniformity and hence the irrigation efficiency. The high discharge that may result in runoff, is balanced by the capacity of the emitter to operate for short cycles (typically one-minute frequent pulses), to deliver the required irrigation application in several batches to make infiltration more effective.

Technology description

Depending on the size of the nozzle adjusted to the emitter the discharge ranges from 30 to 100 l/h under a pressure from 0.5 to 2.0 bar. This high discharge will result in instant application rates that overpass the infiltration capacity of most agricultural soils. Consequently the operation is divided in short cycles (typically 1 or 2 minutes) repeated as required. Considering that a 200-m irrigation block takes around 1 minute to get filled and pressurized when switched on, an anti-leakage membrane has been added that closes the emitter at a pressure of 0.35 bar. Thus the system pressurization is almost instantaneous, allowing a high distribution uniformity. A pressure

regulation device is under development to keeps a uniform distribution with a single nozzle size.

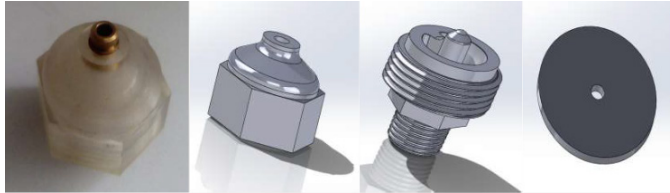

Anti-leakage emitter scheme

Features that make this technology suitable for the context of Egypt, Tunisia and/or Morocco and for the use with treated WW

The main advantage of this technology is its capacity to withstand treated wastewaters with a high content of suspended solids, that normally require the use of fine filtration systems or frequent cleaning solutions when distributed with micro-irrigation drippers. Indeed, if the fine filtration requires a constant maintenance that many drip irrigation farmers don't respect in the long term, this solution accepting coarse filtration may be better undertaken by low skilled farmers. This innovative emitter has been evaluated with suspended solids in the 2 to 4 g/L concentration range, without any relevant clogging phenomena.

This indicates that it is suitable for the use with coarse-filtrated treated wastewaters characterized by high contents of suspended solids.

Results obtained in MADFORWATER relatively to this technology

During the project development the emitter has been designed, prototyped and evaluated experimentally regarding its hydraulic performance and clogging sensitivity with various type of physical contaminants (particles, see graph below, and fibers). The system has been also evaluated in terms of fluid mechanics by numerical simulation. The tests in laboratory with synthetic effluents, developed so as to reproduce the effluents of the different wastewater types targeted by MADFORWATER were successful. Further tests conducted with real treated wastewater effluents in experimental sites managed by Irstea confirmed the laboratory results over a 10 weeks period.

Clogging evaluation with fibers up to a concentration of 2 g/L (50-60 μ m diameter) with emitter position up and down

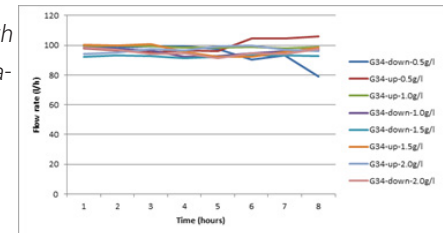

Specific obstacles relative to the application of this technology with treated WW, in Egypt, Tunisia and/ or Morocco

The practices related to the use of this type of emitter are different from those relative to the existing drip irrigation systems. A time for adaptation is necessary along with demonstrations after the end of the project. The high discharge of this emitter is not suitable for all type of crops, and it may be necessary to change the size of the irrigation pipelines in comparison to standard drip irrigation systems.

3 - A consolidated model to optimize irrigation with water of different qualities

Type of crops “targeted” by this technology

The model was tested on several fruit crops (e.g. tomato, potato) and field crops (e.g. wheat, maize).

Technology description

Safe Irrigation Model (SIM) is a daily bucket model used to assess crop water requirement by using freshwater, treated wastewater or mixes water. The model is adapted to various irrigation systems,

water of different qualities, different soil types and crop varieties. In the case of treated wastewater, two main parameters are taken into account: i) water salinity and ii) concentration of E. coli. The model also allows to assess and control microbial risk. The model is capable of simulating the annual effects of water irrigation events on physical properties of soils and crop yield.

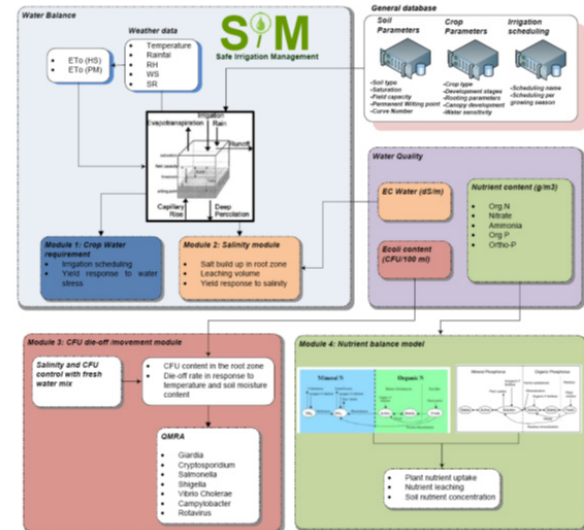

Safe Irrigation Management (SIM) modules

Features that make this technology suitable for the context of Egypt, Tunisia and/or Morocco and for the use with treated WW

This model supports farmers and decision makers in the identification of the optimal water allocation, timing and management options, including the selection of the optimal water mix. The ability of the model to predict future conditions is very useful for projecting the outcomes of various possible irrigation management strategies.

Results obtained in MADFORWATER relatively to this technology

The SIM model is being applied in the Souss-Massa basin in Morocco, to optimize irrigation scheduling and salt balance of specific crops using different qualities of water. To evaluate the model performance a preliminary test was conducted. The figure reported below shows a typical irrigation scheduling. Irrigation is timed automatically. Once the irrigation timing is set, the volume of water can be automatically applied as: i) fixed amount of water (mm); ii) return to fixed soil moisture deficit (mm); iii) return to fixed soil moisture depletion (% of the soil water holding capacity).



An irrigation schedule obtained from the SIM model

Specific obstacles relative to the application of this technology with treated WW, in Egypt, Tunisia and/or Morocco

- Difficulties in obtaining the required source data (especially in relation to the soil hydrological parameters)
- Difficulties in obtaining the data required to calibrate the model for each specific country (crop, meteo, soil, ...)
- The use of wastewater is restricted and often allo-

wed only in controlled experiments.

4 - Innovative biofertilizers for a sustainable agriculture in North African Countries

Type of crops “targeted” by this technology

Large collection of Plant Growth Promoting bacteria were established from several plant hosts, namely sorghum, alfalfa, argan, olive trees, fig trees, citrus and extremophilic plants collected in Mediterranean African countries. The best performing strains were selected to conduct in vivo tests using tomato and durum wheat, crops of interests in Mediterranean African countries. In principle, PGP bacteria inocula can be applied to all crops to enhance their growth, productivity and stress tolerance.

Technology description

Plant growth promoting (PGP) microbes can support plant growth under harsh conditions typically occurring in extreme environments, such as drought and soil salinity that are the main abiotic stresses limiting crop productivity. However, their application to promote crop productivity is still poorly applied at large scale.

MADFORWATER is developing and applying site-tailored PGP inocula as biofertilizers/biostimulants for selected crops of high economical interest for Mediterranean African countries. The selected inocula will be not only endowed with plant-growth activities but also well adapted and efficient in the context of treated WW reuse in stressed and arid lands characteristic of the target countries.

Features that make this technology suitable for the context of Egypt, Tunisia and/or Morocco and for the use with treated WW

In addition to their biofertilization (enhancement of nutrients uptake) and biocontrol (production of antimicrobial and insecticide factors) activities, PGP bacteria can enhance the crop tolerance to extreme climatic conditions typical of North Africa (e.g. soil salinity, drought), so as to increase treated water reuse efficiency.

Results obtained in MADFORWATER relatively to this technology

Large bacteria collections were established from different herbaceous and arborous plant species collected in Tunisia, Morocco and Egypt. We identified the bacterial strains and assessed their resistance to

to osmotic and saline stress and their PGP traits, including biocontrol activity, by means of in vitro tests. We studied in vivo the growth promotion of the best performing strains under greenhouse conditions using tomato and durum wheat, applying different irrigation conditions such as the use of treated WW and the artificial induction of water stress. Our results allowed the identification of different PGP strains of interest as promising candidates to setup biofertilizers adapted to the climatic conditions typical of North African countries. We performed an In-field experiment using the selected PGPR consortium to test the effect of factors including, irrigation with fresh water or TMWW and the use or not of Safe Irrigation Management (SIM model) on Maize crop yield. Our results showed the promoting effect of the use of PGP bacteria to promote plant growth however, additional factor, mainly climatic conditions may play a crucial role in the development of a given crop. A second experiment is ongoing to test the same factors on durum wheat crop.

Specific obstacles relative to the application of this technology with treated WW, in Egypt, Tunisia and/ or Morocco

- Lack of the technology vulgarization and large scale production in Egypt, Tunisia and Morocco
- Lack of awareness among the farming community about biofertilizers' properties
- Lack of regulation and standards for biofertilizer production and commercialization
- Need to clearly regulate the ethical and safety issues.



Experimental set-up in greenhouse to test Plant Growth-Promoting Bacteria effects on tomato plants grown under different water regimes



Experimental set-up in field to test Plant growth Bacteria effects on Maize crop under TMWW irrigation and SIM model application.

5 - Increasing the efficiency of traditional surface irrigation systems in Egypt

Type of crops “targeted” by this technology

Field crops

Irrigation technology mainly used in Egypt for the irrigation of these crops

In the Nile delta in Egypt, open channels (called Mesqas) convey irrigation water to quaternary farm ditches called Marwas which feed over-irrigated fields. The resulting drainage water irrigates downstream fields, or it is mixed

to fresh water and re-enters the distribution system. Consequently, a very high efficiency is achieved at basin level, at the detriment of the quality of water released into drainage canals.

Technology description

The core idea of this technology consists in the conversion of Mesqas and Marwas into optimized pressurized pipes, equipped with hydrants that supply water to downstream gated pipes, provided with calibrated nozzles and feeding fields furrows. This irrigation system allows to maintain in the long term on farm irrigation efficiency, and distribution uniformity thus reducing the drainage volumes. Therefore a greater quantity of fresh water will be available in the upstream canal. As a consequence, the needs to use drainage water would be reduced and the overall environmental conditions in the irrigated area will be improved.

Features that make this technology suitable for the context of Egypt

No water pre-treatments are needed for the application of this technology. In the context of Egypt this technology applies to both irrigation and drainage water.

Results obtained in MADFORWATER relatively to this technology

To minimize energy and maintenance cost, the localized system design was adapted to operate at low pressure (around 0.5 bar). The high discharge rate of the proposed nozzles largely reduce emitters fouling and clogging, problems commonly encountered when irrigating with poor water quality. Particular attention was dedicated to the integration of elastomeric membranes in the nozzle, so as to develop pressure-compensating emitters characterized by a high level of discharge uniformity along the pipe. Field tests have demonstrated that, by using this technology, the amount of drainage water could be reduced by more than 30%.



Pressure (Bars)	Discharge (L/s)
0.15	0.75
0.2	0.8
0.4	0.84
0.5	0.89

Gated pipe with detail of a calibrated nozzle

Specific obstacles relative to the application of this technology in Egypt

The main obstacle might be related to the farmers' acceptance to adapt to the use of a technology which substitutes an old and consolidated flooding system approach.

8 - THE MADFORWATER PILOT PLANTS OF INTEGRATED WASTEWATER TREATMENT

The first Municipal Wastewater Pilot Plant was installed in the Choutrana Wastewater Treatment Plant, Ariana, Tunisia. It is dedicated to the reuse of MWW.

One of the main project's activities was to construct, monitor and optimize 4 Pilot Plants (PPs) in which the most promising technologies for the treatment and agricultural reuse of different wastewater types were effectively integrated: one was installed in Egypt, two in Tunisia and one in Morocco. Different wastewater types were treated and reused in the MADFORWATER pilots: municipal wastewater, textile wastewater and drainage canal water, as specified in the following table:

Pilot Plant	Wastewater type	Location
P1	Municipal wastewater (MWW)	Choutrana, Municipal wastewater treatment plant, Ariana, Tunisia.
P2	Textile wastewater (TWW)	Gwash, industry, Nabeul, Tunisia
P3	Municipal wastewater (MWW)	Agadir, Morocco
P4	Drainage canal water (DCW)	Lake Manzala, Egypt

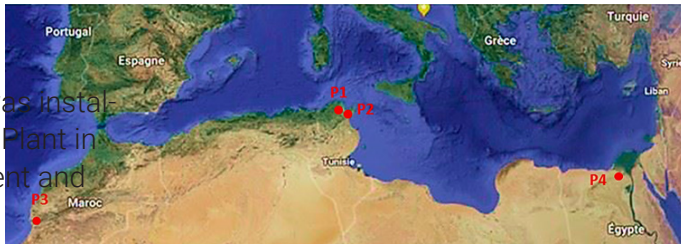

Location and main characteristics of the 4 MADFORWATER pilot plants P1, P2, P3, P4

1. PILOT PLANTS FOR THE TREATMENT AND REUSE OF MUNICIPAL WASTEWATER IN CHOTRANA, ARIANA, TUNISIA (P1) AND AGADIR, MOROCCO (P3)

Two pilot plants were constructed and run for the purpose of municipal wastewater (MWW) treatment and reuse in Tunisia and Morocco.

1.1 PILOT PLANT P1, ARIANA, TUNISIA

The first Municipal Wastewater Pilot Plant was installed in the Choutrana Wastewater Treatment Plant in Ariana, Tunisia. It is dedicated to the treatment and reuse of MWW.

This pilot plant P1 (10m³/d), consists of:

1. A nitrifying trickling filter that provides secondary treatment of organics and ammonia
2. A secondary settler for sludge sedimentation
3. A constructed wetland for heavy metals and remaining nutrients removal
4. A chemical disinfection unit
5. An excess secondary sludge dewatering system.

A satisfying removal efficiency was recorded during the experimental period: 90% for COD, 92% for BOD, 93% for TSS and NTK, 61% for TP and 3-log reduction for E. coli.

The average outlet concentrations were found to be within the limits set by the Tunisian standard NT106.03 for wastewater reuse in agriculture and the Tunisian Decree n°2018-315 for wastewater discharge in the public domain.



The Chotrana municipal wastewater treatment plant (Ariana, Tunisia): the site for the MADFORWATER municipal wastewater pilot plant P1

Treated MWW generated from the pilot plant was used for the irrigation of wheat crops. MADFORWATER partners developed several irrigation technologies suitable for the reuse of treated MWW during the duration of the project, with the aim to reduce water consumption and increase crop production. Selected irrigation technologies were tested in this pilot: a model for irrigation scheduling that takes into account the specific characteristics of the treated wastewater (SIM), innovative mini-sprinklers suitable for treated MWW and hot climates and the supply of

PGPB. PGPB inoculants can be prepared in a way that can be easily used by farmers. However, the social and legal acceptance of this technology still represents a major barrier to its large-scale implementation.

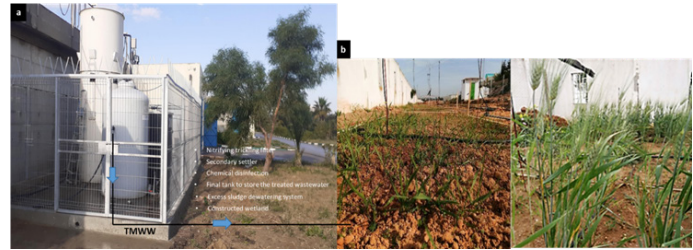

Municipal wastewater treatment pilot P1 in Ariana, Tunisia: a) photo of the pilot plant; b) wheat irrigated with treated municipal wastewater using micro-sprinklers



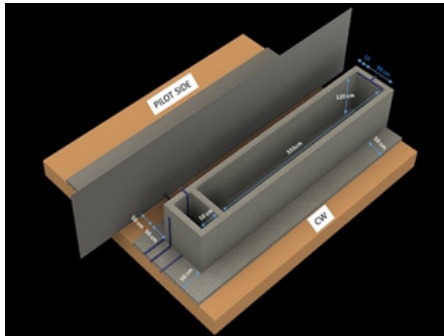

Municipal wastewater treatment pilot P1 in Ariana, Tunisia: details of the constructed wetland

During the first weeks of operation, pilot plant P1 resulted in very high removal rates for the main parameters. However, the accumulation of sludge in the 2 trickling filter units negatively affected the performances of the whole system. The installation of a primary clarifier significantly improved the quality of the effluent. Furthermore, the implementation of the Constructed Wetland (CW) as a tertiary treatment highly ameliorated the effluent quality. Nevertheless, chemical disinfection still resulted necessary, to meet the national and international standards for agricultural reuse of treated WW.

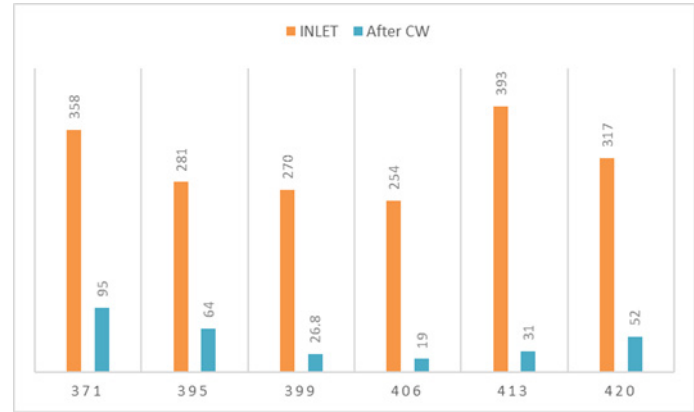

Municipal wastewater treatment in pilot plant P1 in Ariana, Tunisia : BOD5 concentration (mg/L) versus time. CW: constructed wetland.

The proposed treatment train (sedimentation - trickling filter and constructed wetland) appears to be highly suitable for small rural communities (1000-10000 people) characterized by a complete lack of MWW treatment and by a lack of irrigation-quality freshwater. The overall cost of wastewater treatment (0.6-0.7 €/m³) resulted acceptable in the Tunisian context. This treatment represents an affordable technology potentially implementable in several African countries.

1.2 PILOT PLANT P3, AGADIR, MOROCCO

In the Souss-Massa region in Morocco, pilot plant P3 relied on an existing wastewater treatment plant within the station M'zar in Agadir, with a capacity of 75 000 m³/day. The site of L'Mzar MWWTP is located approximately 8.5 km south of the city of Agadir on the coastal dunes of L'Mzar. The western boundary of the site is about 1500 m from the sea. This surface area of the site reserved for the implementation of the project is 200 ha . The treatment Plant process includes an anaerobic lagoon as primary treatment, infiltration on a sand layer, as a secondary treatment and UV disinfection as a tertiary treatment. The monitoring activity showed an average 97-98% removal of BOD₅, COD, TSS, 99% removal of NTK and turbidity, 100% removal of helminth eggs and faecal coliforms and 60% phosphorus removal. The final effluent complies with the Moroccan standards for irrigation with treated wastewater, except for electrical conductivity (3 - 4.5 mS/cm) that slightly exceeds such standard. The high electrical conductivity can be explained by the huge amount of saline wastewater produced from fish processing industries. To overcome this concern, the Moroccan company in

in charge of MWW treatment (RAMSA) has forced fish canneries industries to separate pre-treat their effluent before injecting then in the sanitation network.

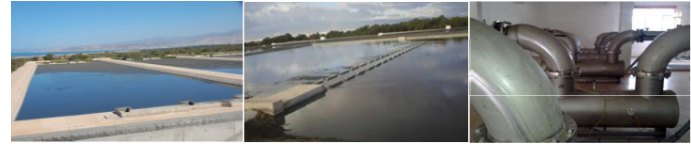

Municipal wastewater treatment in pilot plant P3 in Agadir, Morocco: a) primary treatment: Anaerobic lagoon as primary treatment; b) secondary treatment: sand filter; c) UV disinfection system - tertiary treatment.

The proposed technology for municipal wastewater treatment presents several advantages:

- safe and harmless to humans, the environment and wildlife; it guarantees satisfactory results without addition of chemical products;
- excellent results in reducing suspended matter;
- advanced nitrification and BOD oxidation;
- important bacteriological removal;
- low operating costs;
- easy to operate;
- good environmental integration.

The high salinity of the effluent detected in the water produced by the L'Mzar plant limite its uses for salt sensitive crops. Treated MWW produced by the M'Zar plant was used for the irrigation of young olive trees by means of innovative calibrated nozzles. The irrigation water scheduling was performed using an innovative soil water balance simulation model (SIM). After one year of experiments, irrigation using treated MWW allowed fertilizers and water savings of 570 €/ha, when the SIM model was applied. The crop yields obtained with MWW and freshwater were similar.

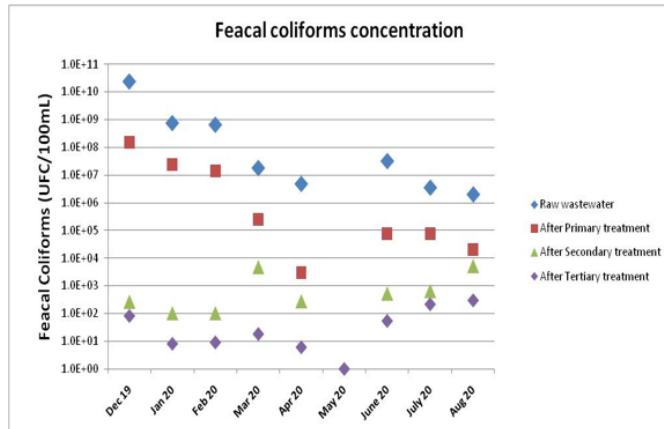

Municipal wastewater treatment in pilot plant P3 in Agadir, Morocco: removal of faecal coliforms over time.

To sum up, both the MWW treatment process tested in the MADFORWATER pilot plants led to the production of high-quality treated wastewater that was successfully utilized for the irrigation of wheat and olive trees. The overall cost for both treatment trains (0.6-0.7 €/m³) resulted acceptable in the context of Tunisia and Morocco. In particular, the trickling filter / constructed wetland combination appears to be highly suitable for small rural communities, but further research is needed to assess the effectiveness of such treatment sequence for the removal of viruses, pathogen bacteria and emerging pollutants.

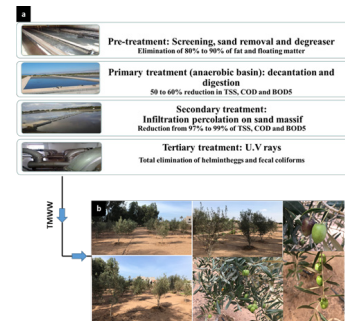

Municipal wastewater treatment in pilot plant P3 in Agadir, Morocco: a) municipal wastewater treatment process in L'Mzar, b) olive trees irrigated with treated municipal wastewater using calibrated nozzles

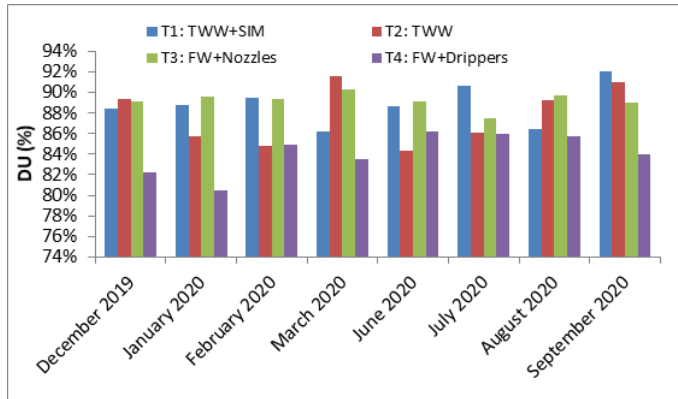

Pilot plant for MWW treatment and reuse in Agadir, Morocco: distribution uniformity values measured for the different irrigation technologies tested, during the experimental period. TWW, treated wastewater; FW, freshwater; SIM: safe irrigation model.

2. PILOT PLANT P3 FOR THE TREATMENT AND REUSE OF TEXTILE WASTEWATER AT THE GWASH INDUSTRY (NABEUL, TUNISIA)

A textile wastewater pilot plant with a capacity of 10 m³/d was installed in the GWash textile industry (Nabeul, Tunisia). It consisted of a coagulation/flocculation unit, a primary clarifier tank, an aerobic

Moving Bed Biological Reactor (MBBR), a secondary clarifier tank, a sand filter and an adsorption column. During preliminary runs of the pilot plant, the MBBR stage resulted not suitable for this type of wastewater, as high salinity and recalcitrant pollutants played an inhibitory role on biomass growth. In light of these results, the developed pilot plant was readapted and coagulation flocculation was applied as a principal treatment prior to the refining processes of adsorption and filtration. The pilot plant led to the production of a high-quality effluent, with average removals equal to 96% for color, 63% for COD, 66% for BOD, 95% for TSS and 100% for NH₄, PO₄, total and fecal coliforms. All effluent values except EC (in average around 18 mS/cm) were within the Tunisian limits for wastewater reuse in agriculture NT106.03 and for wastewater discharge in the public domain (Decree n° 2018-315). The developed technology is characterized by a treatment cost of € 0.15 per m³ wastewater, which is within the range of discharge prices normally paid in Tunisia.



Gwash industry (Korba, Nabeul, Tunisia): the site for pilot plant P2 of textile wastewater treatment and reuse

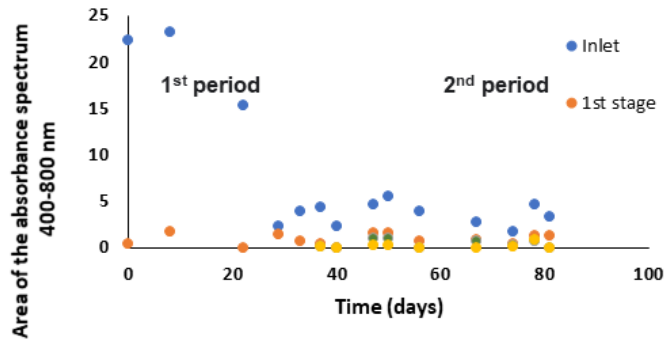

Pilot plant P2 for textile wastewater treatment and reuse in Nabeul, Tunisia: colour removal across the different sections of the water treatment plant. 1st stage: coagulation flocculation unit, 2nd stage: sand filter and 3rd stage: resin

adsorption column.

The treated textile wastewater was reused for the irrigation of sorghum with encouraging results in terms of morphological, physiological and yield parameters. Growth and crop yields were similar between the plots irrigated with treated textile wastewater and those irrigated with freshwater. In both plots, sorghum grain yields were equal to about 1500 kg/ha, in the range of the average values reported for Tunisia in 2017.



Pilot plant P2 for textile wastewater treatment and reuse in Nabeul, Tunisia: installation of the irrigation system in the experimental field

Texile Industries in Tunisia produce about 3 million m³/year of wastewater, that gets typically discharged in the public sewer determining a significant additional load of non-biodegradable organic matter and colour to municipal wastewater treatment plants.

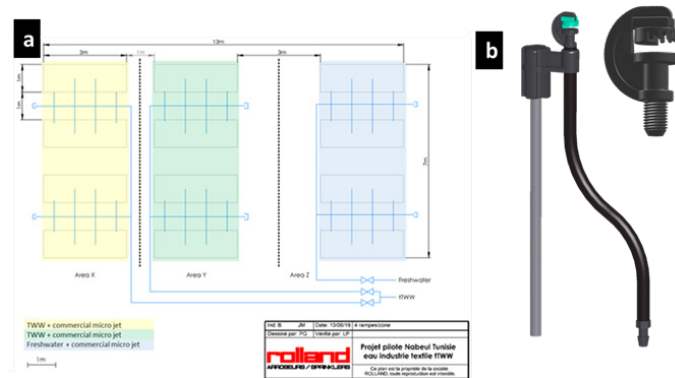

Pilot plant P2 for textile wastewater treatment and reuse in Nabeul, Tunisia: a) schematic diagram for the irrigation network layout (b) microsprinklers

The profile of the soil irrigated with treated TWW was very similar to that of the control soil irrigated with freshwater. After almost 1 year, an increase of electrical conductivity was observed, which may adversely affect salt sensitive crops. Adequate drainage is essential to salinity management. Drainage will help to facilitate leaching of salts downward in the soil. The used irrigation system, consisting of flow-regulated microsprinkler system, is easy to use and operate. Uniform water distribution was attained. However, the microsprinklers needed be maintained and cleaned regularly to remove residues. It is noteworthy as well that the microsprinklers were less effective during windy conditions.

The low-cost process successfully tested in pilot plant P3 for the treatment and reuse of textile wastewater could potentially be implemented at large scale in the North African context, leading to a marked decrease of the textile industry pollutant load. The treated textile wastewater can be reused for the irrigation of non-food crops, as effectively demonstrated in the

the MADFORWATER pilot. A substitute option consists in internal reuse within the textile industry, with a consequent decrease of freshwater consumption and ultimately of the entity of water stress in regions characterized by a high density of textile industries.

3. INTEGRATED PILOT PLANT P4 FOR DRAINAGE CANAL WATER TREATMENT AND REUSE IN THE LAKE MANZALA REGION, EGYPT

The MAD4WATER pilot plant P4, consisting of a facultative lagoon and three types of constructed wetlands tested in parallel (Cascade Hybrid Constructed Wetland-CHCW, Sequent Hybrid Constructed Wetland-SHCW and Floating Bed Constructed Wetland-FBCW), was conducted for more than one year at two different retention times. It was dedicated to drainage canal water (DCW) treatment and reuse. It has been installed near Lake Manzala in Egypt, with a capacity of 250 m³/d. A flow-sheet of the water treatment section is reported here next.

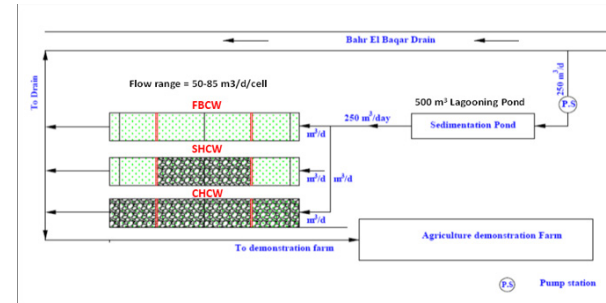

Gwash industry (Korba, Nabeul, Tunisia): the site for pilot plant P2 of textile wastewater treatment and reuse

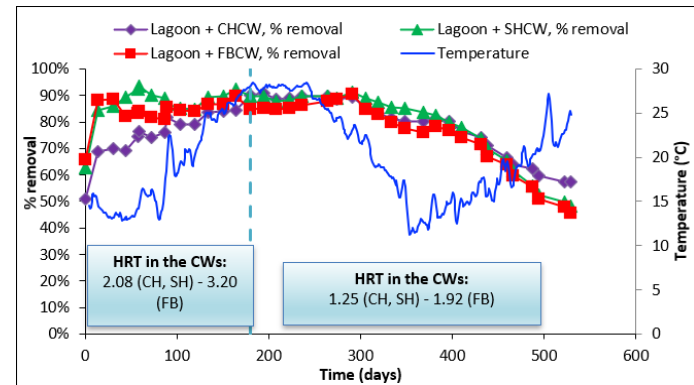

Pilot plant P4 for drainage canal water treatment and reuse in Lake Manzala, Egypt: ammonium removal efficiency versus time. HRT: hydraulic retention time. CWs: constructed wetlands.

The combination of lagooning and cascade hybrid constructed wetland led to the highest removal efficiencies, i.e. 70% for BOD, 66% for COD, 90% for TSS, 83% for total nitrogen, 81% for PO₄, 1.9-log reduction for total coliforms and 2.2-log reduction for fecal coliforms, under the optimal operational condition (2.1-day retention time in the constructed wetland and 2-day retention time in the lagoon). The average effluent concentrations (39 mg/L for COD, 16 mg/L for BOD, 13 mg/L for TSS, 3 mg/L for total nitrogen, 1.1 mg/L for PO₄, 220 MPN/100 mL for fecal coliforms) were compliant with the Egyptian standards for the irrigation of cereals and non-food crops, such as cotton. The decrease in retention time of the constructed wetlands, tested during the second part of the monitoring period, determined a marked reduction of the treatment efficiency.

Treated and semi-treated drainage canal water (sampled after the lagooning treatment and before the constructed wetlands) were reused for the irrigation of cotton plants. Calibrated nozzle gated pipes were used to irrigate a section of the pilot plant, and compared in another section with traditional furrow irrigation, largely implemented in the Nile Delta. The

calibrated nozzle gated pipe technology was tested. It allowed to save between 14 and 23% of irrigation water – depending on the type of water used – without any decrease in cotton yield. Irrigation with semi-treated drainage water led to the highest cotton yield, for both gated pipe and surface irrigation (1780 and 1690 Kg/ha, respectively). These experimental yields were significantly higher than the yields provided by the index mundi site, equal to 762 Kg/ha in Egypt for 2019. The water productivities obtained with both treated and semi-treated drainage water were quite high, without any significant difference between the two irrigation techniques.

To sum up, the combination of facultative lagoons and constructed wetlands showed a great potential for drainage canal water treatment in the Nile Delta. With careful design and planning, these combined technologies can treat drainage canal water leading to the production of an irrigation-quality effluent, with an extremely low energy consumption and a null consumption of chemicals. Also the use of the calibrated

nozzle gated pipe system could significantly reduce the amount of water supplied at field level, thus reducing the amount of drainage water, without reducing the crop yield. The large-scale implementation of these technologies in the Nile Delta could lead to a significant saving in the consumption of freshwater derived from the Nile river, a relevant decrease in the pollutant load ultimately discharged into the Mediterranean Sea and a marked improvement of the quality of irrigation water.



Pilot plant P4 for drainage canal water treatment and reuse: a) setting up of a sequenced hybrid constructed wetland in Lake Manzala in Egypt, b) cotton plants irrigated with treated drainage canal water using gated pipes.

4. Conclusions

In the MADFORWATER project, 4 pilot plants of integrated WW treatment and reuse were designed, installed in Tunisia, Egypt and Morocco and operated for at least 1 year. Each pilot was articulated into a WW treatment section and an irrigation section. The treated WW were MWW (pilots P1 and P3), textile WW (P2) and drainage canal water (P4).

Regarding the WW treatment technologies, two treatment trains were developed and/or assessed for municipal WW: nitrifying/denitrifying trickling filter + CW (pilot P1) and sedimentation / sludge digestion + sand filtration + UV disinfection (P3). Both technology combinations resulted to be capable to produce a high-quality effluent without any energy consumption for BOD or ammonium oxidation and without any supply of chemicals. In particular, pilot P3 resulted capable to produce an effluent compliant with cat. A of the ISO 16075 standard (water suitable to irrigate food crops consumed raw) and with cat. B of the EU 2020/741 regulation (water suitable to irrigate food crops consumed raw where the edible part is produced above ground and is not in direct contact with reclaimed water).

Regarding the treatment of drainage canal water, the combination of facultative lagooning and hybrid CWs tested in pilot 4 proved capable to transform drainage canal water (whose composition is similar to that of a low-strength MWW) in a high-quality effluent, compliant with category C of the EU 2020/741 regulation (irrigation of crops consumed raw, with the edible part above ground and not in contact with irrigation water, irrigation restricted to the use of drippers) and category B of the ISO 16075 standard (irrigation of food crops consumed after cooking). The technology combination tested in pilot P4 is characterized by a near-zero energy consumption (no aeration energy) and a null consumption of chemicals. Its large-scale implementation in the Nile Delta could lead to a marked improvement of the quality of irrigation water, a significant saving in the consumption of freshwater derived from the Nile river and a relevant decrease in the pollutant load ultimately discharged into the Mediterranean sea.

Regarding the treatment of textile WW, the combination of coagulation/flocculation with sand filtration and dye adsorption tested in pilot P2 proved capable to treat a very strong and highly saline textile WW,

the combination of coagulation/flocculation with sand filtration and dye adsorption tested in pilot P2 proved capable to treat a very strong and highly saline textile WW, leading to an effluent compliant with category C of the ISO 16075 standard (irrigation of non-food crops). The low-cost treatment process successfully developed in pilot plant P2 could potentially be implemented at large scale in the North African context, leading to a marked decrease of the pollutant load discharged by textile industries in municipal treatment plants. The treated textile wastewater can be reused for the irrigation of non-food crops, or internally reused within the textile industry.

As for the irrigation sections of the pilots, in all the four field pilots the use of the treated WW produced by the WW treatment section of each pilot led to crop production performances (crop yield and other agronomic parameters) higher (P1) or substantially equal (P2, P3) to those attained in the plots irrigated with freshwater. In pilot P4, for both cotton and sugar beet the yields obtained with treated drainage water

were compared with those obtained with semi-treated water (lagooning only), but not with freshwater. However, the yields obtained with treated drainage water resulted higher than the typical yields reported in the literature for the tested crops. These important results indicate that the WW treatment technologies implemented in the 4 MADFORWATER pilots allowed to produce treated WW that can be effectively be used for the irrigation of typical crops of the North African region.

All the innovative irrigation technologies tested in the field pilots, (calibrated nozzle, micro-sprinkler, gated pipe) resulted effective and performed positively from a hydraulic standpoint. In pilots P3 (reuse of MWW) and P4 (reuse of DCW), the MADFORWATER innovative technologies were compared with the technologies traditionally used by farmers for the same crops (olive trees, cotton, sugar beet). In P3, Rolland's calibrated nozzles performed better than traditional drippers in terms of distribution uniformity. In P4, the innovative combination of a gated pipe with calibrated nozzles performed better than traditional surface irrigation in the case of cotton, whereas in the case of sugar beet this innovation allowed a 13-

-16% water saving but it determined a minor decrease in water productivity.

The application of SIM, an innovative irrigation scheduling model adapted to the use of treated WW tested in pilot P3, led to a 13% saving of the amount of irrigation water required. On the other hand, the economic gain associated to the 13% saving in water was offset by the higher amount of fertilizers required by the "SIM treatment", as a result of the lower amount of nutrient-rich treated MWW supplied to the crops. Thus, in case of irrigation with a nutrient-rich treated MWW, the choice to apply or not a model to optimize irrigation scheduling and minimize the amount of water supplied is a complex one, that should result from a comprehensive evaluation of the economic and agronomic pros and cons of each option.

The application of plant growth promoting bacteria (PGPB) in a wheat field (tested in pilot P1) led to a statistically significant increase in crop yield and water productivity. This result represents an important confirmation of PGPB effectiveness in enhancing crop growth and crop resistance to water stress. However, several barriers still need to be removed in

order to reach a large-scale implementation of this promising technology: the social acceptance, the legal framework and the operational cost.

Overall, the four pilot plants of WW treatment and reuse designed, developed and operated in the framework of MADFORWATER represent a significant step forward towards the development, adaptation to the North African context and implementation of integrated, low-cost effective technologies for the treatment of different WW types typical of Tunisia, Morocco and Egypt, and for their effective reuse for the irrigation of different type of crops by means of innovative technologies adapted to the use of treated WW and capable to determine significant savings in the amount of irrigation water required.

In addition, the MADFORWATER field pilots allowed the SMEs SKE and Rolland to gain a considerable know how on the design and operation of technologies for WW treatment and reuse adapted to the North African context. This key result opens up relevant market opportunities for SKE and Rolland in Mediterranean African countries, as illustrated in Deliverable 6.3.

Lastly, the numerous capacity building activities organized in Tunisia, Morocco and Egypt in the framework of MADFORWATER in relation to the technologies implemented in the 4 pilot plants allowed North African research institutions, farmers, WW managers, basin authorities and policy makers to gain relevant experience on the selection, implementation and operation of technologies for an effective treatment of different wastewater types and for their agricultural reuse. The combination of these results is expected to contribute to the increase of water security in Egypt, Morocco and Tunisia.

For more info about the project visit the MADFORWATER website at: www.madforwater.eu or contact us: dario.frascari@unibo.it.



This project has received funding from the European Union's Horizon 2020 research and innovation programme under grant agreement No. 688320.

The communication reflects only the author's view and the EASME is not responsible for any use that may be made of the information it contains.