

Optical Sensitivity of a Monolithic Integrated InP PIN-HEMT-HBT Transimpedance Amplifier

A. Matiss¹, G. Janssen², R. M. Bertenburg², W. Brockerhoff¹, F.-J. Tegude¹

¹ University of Duisburg-Essen, Solid State Electronics Department, Lotharstrasse 55 / ZHO, D-47057 Duisburg, Germany, Phone: +49 (0)203 379-4605

² IPAG-Innovative Processing AG, Lotharstrasse 55, D-47057 Duisburg, Germany, Phone:+49 (0)203 379-4527

Abstract — To improve sensitivity of optical receivers, a special integration concept is chosen that includes a pin-photodiode, high-electron mobility transistors (HEMT) and heterostructure bipolar transistors (HBT) on a single substrate. This work focuses on the optimization of the amplifier design to achieve lowest input noise currents of a transimpedance amplifier, and thus highest receiver sensitivity. The respective advantages of the components used are investigated with respect to the noise behaviour. Different circuits have been simulated and an amplifier design is presented that best fits the requirements for high optical sensitivity.

I. INTRODUCTION

The purpose of this work is to evaluate certain design criteria that affect the optical sensitivity of receivers. Any optoelectronic receiver has a minimum optical input power level necessary to resolve a certain bit pattern at the output of the amplifier. This minimum power level defines the optical sensitivity. To increase the sensitivity of such a receiver a specific integration concept based on InP is chosen that includes pin-diode, high-electron mobility transistor (HEMT) and heterostructure bipolartransistor (HBT) structures on a single substrate. This work focuses on the simulation of a transimpedance amplifier receiver system for 10GHz bandwidth. The simulation is based on realized and measured components presented in this work. InP allows the realization of photodiodes with good detector performance at 1.55 μ m wavelength, where optical fibres show excellent transmission characteristics like minimum dispersion and low attenuation.

After a résumé of the optical sensitivity and the introduction of the layer system the amplifier concept is presented and a short description of the different stages is given. In the following section, the optimization of the circuitry for maximum optical sensitivity is presented and any design parameter influencing the sensitivity is investigated in detail.

II. OPTICAL SENSITIVITY

The optical sensitivity is the minimum input signal power required to drive an optoelectronic device. An input power below this limit would result in an output signal that is very close to the output noise power of the amplifier and therefore would not pass a bit error rate

(BER) test. For 10Gbit systems a BER of 10^{-12} ($Q=7$) is commonly used to compare the results. The Q -factor is a parameter for the digital eye aperture. The sensitivity P_{min} of a receiver with a photodetector in dependence on the spectral input noise current density i_{na} is given by:

$$P_{min} = \frac{Q}{R_{pin}} \cdot \frac{1+r}{1-r} \cdot \sqrt{\langle i_{na}^2 \rangle} \quad (1)$$

with R_{pin} as the DC responsivity of the pin-diode. The optical reflection coefficient r of the photodetector is assumed to be zero. P_{min} defines the necessary minimal optical input power at the photodetector to achieve the desired BER. When describing receiver sensitivity, it is common to factor out the detector-dependent parameters in order to compare receivers independently of the type of photodetector used [5,6]. In the pin-diode case, the receiver sensitivity ηP_{min} can be calculated by:

$$\eta \cdot P_{min} = Q \cdot \frac{h \cdot c}{q \cdot \lambda} \cdot \sqrt{\langle i_{na}^2 \rangle} \quad (2)$$

The spectral input noise current density is a function of the transimpedance Z_T of the amplifier and the spectral output noise voltage $v_{n,out}$.

$$i_{na} = \frac{v_{n,out}}{Z_T} \quad (3)$$

The spectral input noise current i_{na} only refers to the electrical part of a receiver. To take the photodetector into account and to get a noise parameter for the input power, the electrical spectral input noise current is transferred into the optical spectral input noise power density p_{na} :

$$p_{na} = \frac{i_{na}}{R_{pin}} = \frac{v_{n,out}}{Z_T} \cdot \frac{1}{R_{pin}} = \frac{v_{n,out}}{GC} \quad (4)$$

The conversion gain GC of an optoelectronic circuit describes the transfer function of an amplifier with a photodetector. The spectral optical input noise power density p_{na} results in an equivalent optical input noise power $\langle P_{na}^2 \rangle$ by integrating over the bandwidth BW of the receiver.

This results in the optical sensitivity P_{min} :

$$P_{\min} = Q \cdot \sqrt{\langle p_{na}^2 \rangle} = Q \cdot \sqrt{\int_0^{BW} |p_{na}|^2 df} \quad (5)$$

which is better suited for the analysis of integrated photodetectors compared to eq.1.

For further discussion, the spectral input noise current i_{na} (eq.3) is used for describing the noise performance of the amplifier, and the spectral input noise power p_{na} (eq.4) allows the characterization of the whole receiver including photodetector and amplifier.

III. INTEGRATION CONCEPT

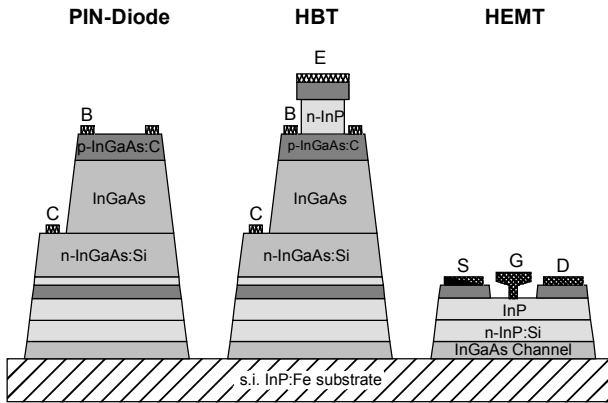

Fig. 1 InP based layer system for PIN-HBT-HEMT integration concept with topological schematic of the single devices of the amplifier.

A monolithically integrated combination of PIN, HEMT and HBT on a single substrate was chosen. Each device shows unique advantages in performance that contribute to the optical sensitivity of a receiver. A HEMT is well suited as low-noise device due to its strong correlation between the gate and channel noise that causes a drop of the equivalent input noise current i_{na} [1,2]. The HBT is suitable for use in buffer stages due to the ideally constant voltage drop over the base-emitter junction, which stabilizes the transistor against load influence. It also has smaller lateral dimensions compared to the HEMT and therefore is easier to implement into small circuits. Additionally, the layer-system of the HBT can be used to integrate a PIN-diode into the circuitry of the transimpedance receiver [3,4]: the p-doped base and the n-doped collector can simultaneously be used for the PIN-diode. A schematic view of the layer system including the device structures is shown in figure 1. Due to the combined use of the base-collector layers by HBT and PIN the layer thicknesses of the collector and the base have to be adjusted to fit each device requirements. This results in a certain performance tradeoff for both devices. Another critical element is related to topology of the total circuit. Because the HBT is build upon the HEMT layer structures, its vertical dimension becomes a critical parameter for the circuitry layout. A total height difference from top of the HEMT up to the HBT is about 1000nm for the chosen layer structure.

IV. AMPLIFIER DESIGN

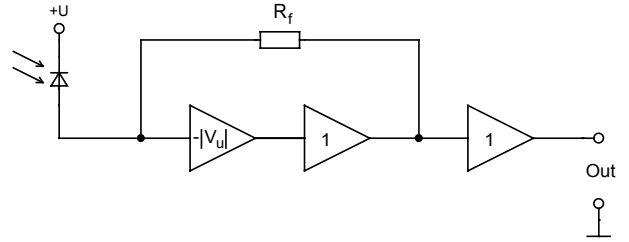

Fig. 2 Three stage amplifier concept with feedback resistor and photodiode.

The amplifier design consists of three stages with a pin-diode at the input as shown in fig.2. A transimpedance amplifier is the best receiver concept for further processing of the signal due to the photocurrent as output parameter of the photodetector. It contains an amplifier stage and two buffer stages to compensate feedback effects.

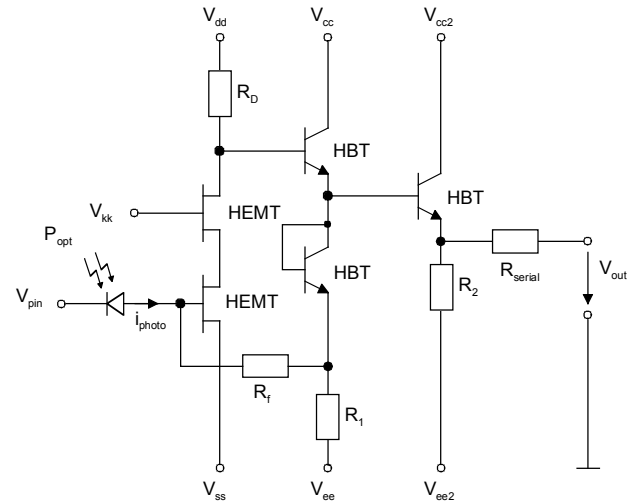

Fig. 3. Circuit design of monolithically integrated optoelectronic receiver for evaluation of optimum optical sensitivity.

The first stage is based on a HEMT cascode that provides a lower spectral input noise current compared to an equivalent HBT cascode. The cascode ability to reduce the MILLER effect contributes to the good noise behaviour as discussed in section IV-C. To stabilize the amplifier, the output of the first stage has to be decoupled from unwanted influence of the load. A capacitive load significantly decreases the bandwidth of the HEMT cascode. Therefore, a HBT emitter follower has been added to the HEMT cascode output. The low HBT input capacitance provides the HEMT with a low load capacitance due to its small emitter size. To reduce a current flow over the feedback resistor back to the input of the amplifier, a levelshifter is used to reduce the voltage drop at the feedback resistor. The levelshifter is realized by shorting the base collector terminals of the HBT and thus using the base-emitter diode to shift the voltage by about 0.7V. To avoid mismatches between the output and the load, a HBT emitter follower with a serial resistance has been implemented as a third stage to fit the output to 50Ω.

IV. OPTIMIZATION

The resulting three stage amplifier was optimised to best fit minimum input power levels. Therefore, the influence of various parameters on the optical sensitivity was investigated in detail. All influences investigated are located in the first amplifier stage of the receiver. Other noise sources in the second or third stage did not contribute to the spectral output noise voltage.

A. Cascode Load Resistor R_D

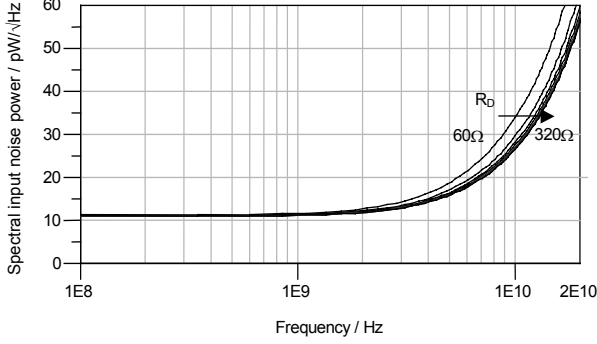

Fig. 4. The impact of the cascode load resistor on the spectral input noise power over frequency.

The cascode load resistor R_D in the amplifier stage affects the optical sensitivity at high frequencies. This influence can be minimized by increasing its value. The influence is due to the thermal noise behaviour of resistors. The equivalent thermal noise current declines with the resistance value. Thus, small load resistance values R_D result in a high equivalent input noise current of the amplifier stage, and therefore increase the spectral input noise power p_{na} (see eq.4). Alternatively, a HEMT with shorted gate-drain contact could be used as an active load to minimize noise effects. An active load reduces the required bias voltage to drive the cascode because the resistive load consumes much more power than the HEMT does. On the other hand, the implementation of a common resistor load leads to a higher adjustability of the first stage.

B. Gate Width

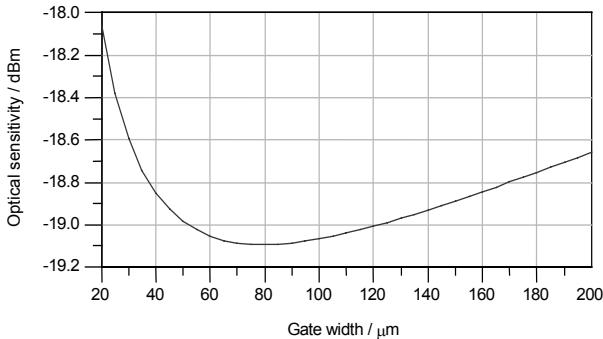

Fig. 5. Optical sensitivity of the receiver in dependence on the gatewidth of the HEMT.

The gate width shows a minimum of the optical sensitivity around $80\mu\text{m}$ (Fig.5) at 10GHz bandwidth using eq.5. This minimum could be explained by the mismatch between the amplifier and the pin-diode. There

is an optimum gate width that results in an optimum generator reflection coefficient Γ_{opt} of the amplifier that best fits the pin-diode output reflection coefficient Γ_{pin} .

C. Feedback Resistor R_f

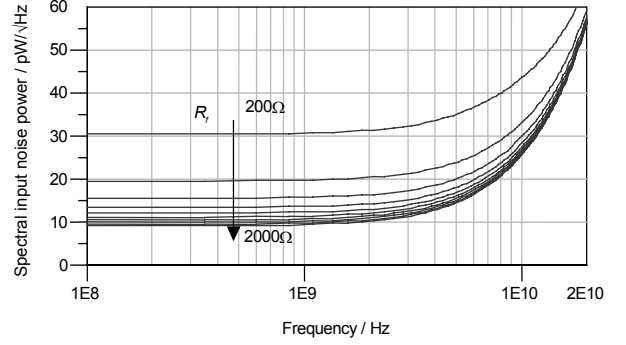

Fig. 6. Impact of the feedback resistor on the spectral input noise power over frequency.

Furthermore, the optical sensitivity is dominated by the feedback resistor (Fig.6). The spectral input noise power decreases with rising value of the feedback resistor over a wide frequency range. The influence of the thermal noise current of the feedback resistor is critical to the amplifier due to the direct link of the feedback conductor to the input of the HEMT. The cascode circuit concept reduces the input capacitance of the amplifier by reducing the MILLER effect and thus increasing the gain-bandwidth product of the HEMT cascode. This allows larger feedback resistors that result in lower equivalent input noise currents.

D. Responsivity of the PIN-Diode

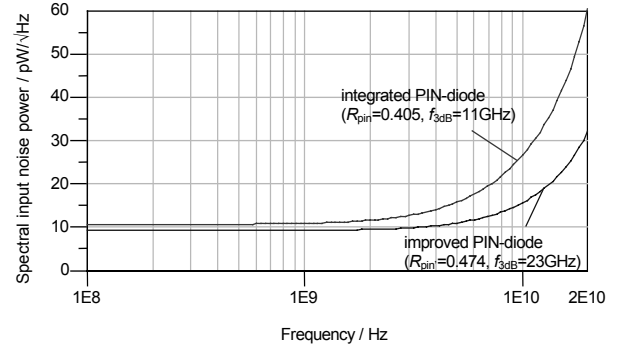

Fig. 7. Spectral input noise power versus frequency for two different PIN-diodes.

Due to a dependence of the responsivity of the pin-diode on the spectral input noise power (Fig.7), the best results will be achieved by increasing the responsivity to a maximum value. This can be explained with the improved signal-to-noise ratio caused by a higher input current from the pin-diode with a higher responsivity. This influence covers the whole bandwidth of the receiver. Even small improvements in responsivity by increasing the thickness of the intrinsic region of the pin result in a significant drop of p_{na} . Another important aspect is the bandwidth of the pin-diode. For frequencies above the bandwidth of the integrated pin-diode ($f_{3\text{dB}}=11\text{GHz}$) the spectral input noise power raises stronger than for the improved pin-diode with a higher

bandwidth of $f_{3dB}=23\text{GHz}$. Although the improved pin-diode has a higher bandwidth due to lower capacitances, the main influence on p_{na} up to 10GHz is located in the responsivity of the diode where the small difference of $\Delta R_{pin}=0.07\text{A/W}$ cause a drop of p_{na} from $27\text{pW}/\sqrt{\text{Hz}}$ down to $16\text{pW}/\sqrt{\text{Hz}}$.

E. Microstrip Transmission Lines

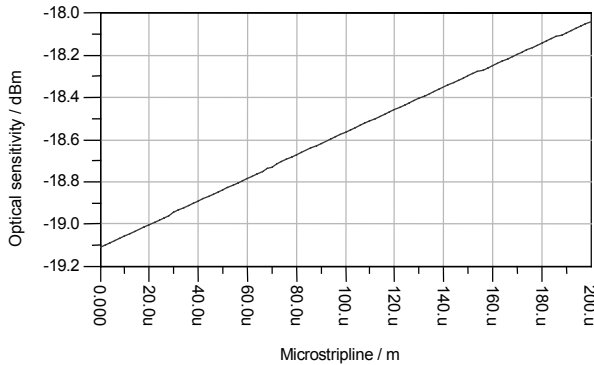

Fig. 8. Influence of a microstripline of variable length between the output of the pin-diode and the input of the amplifier on the optical sensitivity.

Furthermore, the length of the microstrip line between pin-diode and the input of the amplifier also influences the optical sensitivity (see fig. 8). It was not possible to improve the performance of the whole circuit by adding a matching network between the pin-diode and the transimpedance amplifier.

It also turned out that not only the conductor between the pin-diode and the input of the HEMT cascode influence the noise behavior of the amplifier. Almost any piece of transmission line carrying the RF-signal contributes to the spectral input noise current of the transimpedance amplifier, especially the design and length of the feedback path is critical to the optical sensitivity.

V. DEVICE PARAMETERS AND RESULTS

PIN	f3db	11 GHz
	Rpin	0.405 A/W
	Diameter	20um
HEMT	ft	130 GHz
	fmax	150 GHz
	NFmin	0.9 dB
	Size	2x40x0.2um ²
HBT	ft	110 GHz
	fmax	140 GHz
	NFmin	4 dB
	Size	2x5um ²

Table I. Device parameters

The measured parameters of the single devices are shown in table I. The simulated receiver with the integrated pin-diode, HEMT and HBT achieved an optical sensitivity of $P_{min}=-19\text{dBm}$ with a conversion gain $GC=250\text{V/W}$ (46dB). The power dissipation was

about 150mW and the group delay variation of the amplifier was below $\Delta\tau<6\text{ps}$. The last output buffer stage provided a reflection coefficient of less than $\Gamma_2<-10\text{dB}$.

VI. SUMMARY AND CONCLUSION

The optical sensitivity depends on the responsivity of the photodetector ($P_{min}\propto 1/R$) and on the following transimpedance amplifiers noise behaviour. The achieved minimum power level required for the presented amplifier design is at $P_{min}=-19\text{dBm}$ (10GHz bandwidth) for a pin-diode with a responsivity of $R=0.405\text{A/W}$. Simulations of pin-diodes with a slightly higher responsivity ($\sim 0.48\text{A/W}$) increased the sensitivity to $P_{min}=-22\text{dBm}$ (10GHz bandwidth). The receiver sensitivity $\eta \cdot P_{min}=-24\text{dBm}$, as described in eq.2, shows the capabilities of the integration concept for optical receiver. This influence of the electrical network to the sensitivity is caused by three elements. All three main influences are located in the first stage of the amplifier: The feedback-resistor as shown in figure 6, the drain-resistor as shown in figure 4 and the transistor itself.

The HEMT shows better noise performance than the HBT and also in dependence on its gate width it shows a minimum of input noise current. On the other hand, the dimensions of the connection between the pin-diode and the input of the first stage influence the spectral input noise current. To fit the optimal generator reflection coefficient of the pin-diode, the microstrip line between the pin-diode to the amplifier has to be short.

It has been shown that with this integration concept, based on real components, good optical sensitivities have been simulated. For further improvement it is possible to optimize the layer thickness of the HBT to increase the responsivity of the pin-diode, or even use a separate layer system on top of both HEMT and HBT to get best performances for HBT and PIN. Common values for stand-alone pin-diodes are $R_{pin}>0.8\text{A/W}$.

REFERENCES

- [1] A. Cappy, „Noise Modeling and Measurement Techniques“, *IEEE Transactions on Microwave Theory and Techniques.*, vol.36, no. 1, January 1988
- [2] M. W. Pospieszalski, „Modeling of Noise Parameters of MESFET's and MODFET's and their Frequency and Temperature Dependence“, *IEEE Trans. Microwave Theory Tech.*, vol.37, pp.1340-1350, Sept. 1989
- [3] D. Huber, et al. „InP/InGaAs Single HBT Technology for Photoreceiver OEIC's at 40 Gb/s and Beyond“, *IEEE Journal of Lightwave Technology.*, vol.18, no.7, July 2000
- [4] E. Sano, M. Yoneyama, H. Nakajima, Y. Matsuoka, „A Monolithically Integrated Photoreceiver Compatible With InP/InGaAs HBT Fabrication Process“, *IEEE Journal of Lightwave Technology*, vol. 12, no. 4, April 1994
- [5] R.G. Smith, S.D. Personick, „Receiver design for optical fiber communication systems in semiconductor devices for optical communication“, Berlin: Springer-Verlag, pp.89-160, 1982
- [6] A.E. Stevens, „An Integrate-and-Dump Receiver for Fiber Optic Networks“, doctor thesis, Columbia University, 1995, pp.33-50